

# brother®

# TZ TAPE

# P-touch®

ELECTRONIC LABELLING SYSTEM

# PT-7600

## USER'S GUIDE MODE D'EMPLOI



- Read this User's Guide before you start using your P-touch Labeller.
- Keep this User's Guide in a handy place for future reference.
- Lisez attentivement ce guide avant d'utiliser le P-touch pour la première fois.
- Conservez ce guide dans un lieu sûr en vue de référence ultérieure.

If you encounter any problems with your product, visit our Web site:

<http://solutions.brother.com/>

Si vous rencontrez des problèmes avec votre produit, visitez notre site Web :

<http://solutions.brother.com/>

## **Federal Communications Commission (FCC) Declaration of Conformity (For USA Only)**

Responsible Party : Brother International Corporation  
100 Somerset Corporate Boulevard  
Bridgewater, NJ 08807-0911 USA  
TEL : (908) 704-1700

declares that the product

Product Name : Brother P-touch Electronic Labeling System

Model Number : PT-7600

This device complies with Part 15 of the FCC Rules. Operation is subject to the following two conditions: (1) this device may not cause harmful interference, and (2) this device must accept any interference received, including interference that may cause undesired operation.

This equipment has been tested and found to comply with the limits for a Class B digital device, pursuant to Part 15 of the FCC Rules. These limits are designed to provide reasonable protection against harmful interference in a residential installation. This equipment generates, uses and can radiate radio frequency energy and, if not installed and used in accordance with the instructions, may cause harmful interference to radio communications. However, there is no guarantee that interference will not occur in a particular installation. If this equipment does cause harmful interference to radio or television reception, which can be determined by turning the equipment off and on, the user is encouraged to try to correct the interference by one or more of the following measures:

- Reorient or relocate the receiving antenna.
- Increase the separation between the equipment and receiver.
- Connect the equipment into an outlet on a circuit different from that to which the receiver is connected.
- Consult the dealer or an experienced radio/TV technician for help.

### **Important**

- The enclosed interface cable should be used in order to ensure compliance with the limits for a Class B digital device.
- Changes or modifications not expressly approved by Brother Industries, Ltd. could void the user's authority to operate the equipment.

## **Industry Canada Compliance Statement (Canada Only)**

This Class B digital apparatus complies with Canadian ICES-003.

- IBM is a trademark of International Business Machines, Inc.
- The Brother and P-touch logos are registered trademark of Brother Industries, Ltd.
- Microsoft and Windows are registered trademarks of Microsoft Corporation, USA.
- The names of other software or products used in this document are trademarks or registered trademarks of the respective companies that developed them.

## **Compilation and Publication Notice**

Under the supervision of Brother Industries Ltd., this manual has been compiled and published, covering the latest product's descriptions and specifications.

The contents of this manual and the specifications of this product are subject to change without notice.

Brother reserves the right to make changes without notice in the specifications and materials contained herein and shall not be responsible for any damages (including consequential) caused by reliance on the materials presented, including but not limited to typographical and other errors relating to the publication.

## **Trademarks**

The Brother logo is a registered trademark of Brother Industries, Ltd.

Brother is a registered trademark of Brother Industries, Ltd.

© 2010 Brother Industries Ltd.

- Microsoft, Windows and Windows Vista are registered trademarks of Microsoft Corporation in the United States and other countries.
- The names of other software or products used in this document are trademarks or registered trademarks of the respective companies that developed them.



# Before Using Your P-touch Labeller

Thank you for purchasing the PT-7600.









Your new P-touch labeller is an easy to operate, feature packed labelling system that makes creating professional, high quality labels a breeze. In addition to easy label creation via pre-formatted label layouts, the P-touch labeller editing software features advanced label formatting, block formats, bar codes and auto-numbering functions.

## Safety precautions

To prevent injury and damage, important notes are explained using various symbols. The symbols and their meanings are as follows:

 <b>WARNING</b>	Tells you what to do to avoid the risk of injury.
 <b>CAUTION</b>	Tells you about procedures you must follow to prevent damage to the P-touch labeller.













The symbols used in this manual are as follows:

	Action NOT allowed.		DO NOT disassemble the product.
	DO NOT splash the product with or immerse the product in water.		DO NOT touch this part of the product.
	Mandatory action		Unplugging
	Safety alert		Alerts to the possibility of electrical shock

## WARNING









### Rechargeable battery pack

Follow these guidelines to avoid fire, heat, damage, and electric shock.

-  Do not use this P-touch labeller with any rechargeable battery pack other than that specified.
-  To recharge the rechargeable battery pack, insert the rechargeable battery pack into the P-touch labeller, and then use AD-18 designed specifically for this P-touch labeller.
-  Do not insert or use the rechargeable battery pack in any equipment other than the P-touch labeller. Do not directly connect it to a power supply, car cigarette lighter or electrical outlet.
-  Do not expose the rechargeable battery pack or the P-touch labeller with the rechargeable battery pack installed to pressure, heat, electric charge or microwaves.
-  Do not place the rechargeable battery pack or the P-touch labeller with the rechargeable battery pack installed near a fire or in a location exposed to heat or high temperatures (for example, near a flame or stove, in the sun, or in a location where the temperature is 140 °F or more, such as in a hot car).
-  Do not allow the rechargeable battery pack to get wet.
-  Do not short-circuit the terminals of the rechargeable battery pack or the P-touch labeller with the rechargeable battery pack installed, such as with a metal object.
-  Do not pierce the external casing of the rechargeable battery pack in any way.
-  Take care to prevent damage to the rechargeable battery pack, or the P-touch labeller with the rechargeable battery pack installed.
-  Do not disassemble or alter the rechargeable battery pack or the P-touch labeller with the rechargeable battery pack installed.
-  Do not use a damaged or deformed rechargeable battery pack.
-  Do not use in a corrosive environment (for example, exposed to salty air or salt water, or acidic, alkaline or corrosive gas).
-  Do not insert or remove the rechargeable battery pack when the AC adapter is connected.

### AC adapter







Follow these guidelines to avoid fire, damage, electric shock, or failure.

-  Use only the AC adapter (AD-18) designed exclusively for your P-touch labeller. Failure to observe this may result in an accident or damage. Brother shall not assume any responsibility for any accident or damage resulting from not using the specified AC adapter.
-  Unplug the power cord immediately and stop using the machine during an electrical storm. There may be a remote risk of electric shock from lightning.
-  Do not touch the AC adapter or power plug with wet hands.
-  Do not use the AC adapter in places of high humidity such as bathrooms.
-  Do not use a damaged power cord.
-  Do not overload the power outlet.
-  Do not place heavy objects on, damage or modify the power cord or plug. Do not forcibly bend or pull the power cord.
-  Do not drop, hit or otherwise damage the AC adapter.
-  Make sure that the plug is fully inserted in the power outlet. Do not use an outlet that is loose.

## WARNING









### Batteries (Alkaline/Rechargeable)

Follow these guidelines to avoid leakage, or damage to the batteries.

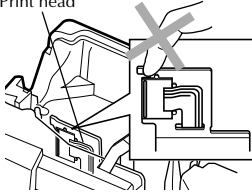
-  Do not use metallic articles, such as tweezers or a metallic pen, when exchanging the batteries.
-  Do not charge the batteries in high temperature locations.
-  Do not throw into fire, heat up, or disassemble the battery.
-  If battery fluid comes into contact with skin or clothes, wash the affected areas thoroughly with clean water. Battery fluid is harmful to skin.
-  If the batteries leak, make sure the fluid does not come into contact with your eyes, as this may result in loss of eyesight. If contact does occur, flush eyes with clean water and seek medical attention urgently.
-  If the batteries begin to emit an odor, overheat, discolor, deform, or any other change occurs during use, charging, or storage, remove the batteries immediately and discontinue use.

### P-touch labeller

Follow these guidelines to avoid fire, damage, electric shock, and choking.

-  Do not allow the P-touch labeller to get wet in any way.
-  Do not touch any metal parts near the print head. The print head becomes very hot during use and remains very hot immediately after use. Do not touch it directly with your hands.  
Print head
- 
-  Do not disassemble the P-touch labeller. For inspection, adjustment, and repair of the P-touch labeller, contact the retail outlet where the P-touch labeller was purchased or your local authorized service center.
-  Plastic bags are used in the packaging of your machine. To avoid danger of suffocation, keep these bags away from babies and children.
-  Disconnect the AC adapter and remove battery immediately and stop using when you notice abnormal odour, heat, discoloration, deformation or anything unusual while using or storing it.
-  Do not use the P-touch labeller with a foreign object in it. If water, metallic substance or any foreign object enters the P-touch labeller, disconnect the AC adapter and remove battery, and contact the retail outlet where the P-touch labeller was purchased or your local authorized service center.
-  To prevent damage, do not drop or hit the machine.
-  Do not touch the blade of the cutter unit.

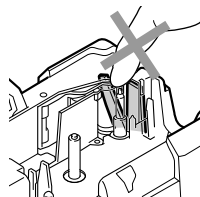



## CAUTION

### **Tape Cutter**

Follow these guidelines to avoid personal injury and damage of the P-touch labeller.





-  Do not open the tape compartment cover when operating the cutter unit.
-  Do not apply excessive pressure to the cutter unit.

### **AC adapter**

-  If you do not intend using the P-touch labeller for an extended period of time, please disconnect the AC adapter from the power outlet and the P-touch labeller to avoid battery leakage or loss of charge.
-  Always hold the plug when disconnecting the power cord from the power outlet.



### **Batteries**

Follow these guidelines to avoid liquid leakage, heat or rupture of the batteries.

-  Do not use old and new batteries together.
-  Check that the batteries are correctly inserted.
-  Do not mix alkaline batteries with other type batteries.
-  If you do not intend using the P-touch labeller for an extended period of time, please remove the battery to avoid battery leakage or loss of charge.
-  Do not let the batteries get wet.

### **P-touch labeller**



Follow these guidelines to avoid personal injury and damage of the P-touch labeller.

-  Place the P-touch labeller on a flat, stable surface such as a desk.
-  Do not place any heavy objects on top of the P-touch labeller. Do not press on the LCD screen.
-  Do not leave the P-touch labeller within reach of children with the back cover open.

### **Tape**

-  Depending on the location, material, and environmental conditions, the label may unpeel or become irremovable, the color of the label may change or be transferred to other objects. Before applying the label, check the environmental condition and the material.

### **Memory**

-  Any data stored in memory will be lost due to failure or repair of the P-touch labeller, or when the batteries expires and the power is disconnected.
-  When power is disconnected for more than two minutes, all text and format settings will be cleared. Any text files stored in the memory will also be cleared.

## General Precautions

- Do not use the P-touch labeller in any way or for any purpose not described in this guide. Doing so may result in accidents or damage to the machine.
- Do not put any foreign objects into the tape exit slot, AC adapter connector, or USB port, etc.
- Do not touch the print head with your fingers. Use a soft wipe (e.g. a cotton swab) when cleaning the print head or the optional print head cleaning cassette (TZ-CL4) when cleaning the print head.
- Do not clean the machine with alcohol or other organic solvents. Only use a soft, dry cloth.
- Do not place the P-touch labeller/battery in direct sunlight or rain, near heaters or other hot appliances, in any location exposed to extremely high or low temperatures (e.g. on the dashboard or in the back of your car), high humidity, or dusty locations. Standard operating temperature range: (10 °C to 35 °C).
- Do not leave any rubber or vinyl on the machine for an extended period of time, otherwise the machine may be stained.
- Depending on the environmental conditions and the applied settings, some characters or symbols may be difficult to read.
- Use only Brother TZ tapes with this machine. Do not use tapes that do not have the  mark.
- Do not pull or apply pressure to the tape in the cassette. Otherwise the tape cassette or P-touch labeller may be damaged.
- Make sure that the release lever is up when closing the back cover. The back cover cannot be closed if the release lever is pressed down.
- Do not try to print labels using an empty tape cassette or without a tape cassette set in the P-touch labeller. Doing so will damage the print head.
- Do not attempt to cut tape while printing or feeding since this will damage the tape.
- It is recommended that you use the USB cable supplied with the P-touch labeller. Should another USB cable need to be used, ensure it is of high quality construction.
- Be careful not to scratch the CD-ROM. Do not place the CD-ROM in any location exposed to high or low temperatures. Do not place heavy objects on the CD-ROM or bend it.
- The software on the CD-ROM is intended for use with the P-touch labeller and may be installed on more than one PC.
- We strongly recommend that you read this User's Guide carefully before using your P-touch labeller, and then keep it nearby for future reference.



# Contents

<b>Before Using Your P-touch Labeller</b> .....	<b>ii</b>
<i>Safety precautions</i> .....	<i>ii</i>
<b>General Precautions</b> .....	<b>vi</b>
<b>Contents</b> .....	<b>vii</b>

## 1. Getting Started ..... 1

<b>Unpacking Your P-touch Labeller</b> .....	<b>1</b>
<b>General Description</b> .....	<b>2</b>
<i>Top view &amp; bottom view</i> .....	<i>2</i>
<i>Keyboard &amp; LCD screen</i> .....	<i>3</i>
<i>Back light</i> .....	<i>4</i>
<b>Power Supply</b> .....	<b>4</b>
<i>AC Adapter</i> .....	<i>4</i>
<i>Batteries</i> .....	<i>5</i>
<i>Rechargeable battery pack</i> .....	<i>6</i>
<b>Tape Cassettes</b> .....	<b>8</b>
<i>Installing a tape cassette</i> .....	<i>8</i>
<b>Turning the P-touch Labeller On/Off</b> .....	<b>11</b>
<b>Changing the Language</b> .....	<b>11</b>

## 2. Label Type Modes ..... 12

<b>Selecting a Label Type Mode</b> .....	<b>12</b>
<b>Normal and Vertical Modes</b> .....	<b>12</b>
<b>Rotate and Rotate &amp; Repeat Modes</b> .....	<b>13</b>
<b>Flag Mode</b> .....	<b>14</b>
<b>Port and Panel1 Modes</b> .....	<b>15</b>
<b>Panel2 Mode</b> .....	<b>16</b>

## 3. Basic Functions ..... 18

<b>Performing Basic Operations</b> .....	<b>18</b>
<i>Choosing functions, parameters, settings and groups</i> .....	<i>18</i>
<i>Choosing the default setting</i> .....	<i>18</i>
<i>Confirming a choice</i> .....	<i>18</i>
<i>Cancelling a choice</i> .....	<i>18</i>

<b>Inputting Label Data .....</b>	<b>19</b>
<i>Entering and editing text .....</i>	19
<i>Entering an accented character .....</i>	21
<i>Entering a bar code .....</i>	22
<i>Entering a symbol .....</i>	24
<b>Formatting the Label .....</b>	<b>27</b>
<i>Specifying a label length .....</i>	27
<i>Specifying a margin size .....</i>	27
<i>Framing the text .....</i>	28
<i>Specifying the character size .....</i>	29
<i>Specifying the character width .....</i>	30
<i>Specifying the character style .....</i>	31
<i>Using the pre-formatted Auto Format templates .....</i>	32
<b>Printing Labels .....</b>	<b>33</b>
<i>Previewing the label layout .....</i>	33
<i>Feeding tape .....</i>	34
<i>Printing a label .....</i>	34
<i>Using special printing functions .....</i>	34
<b>Storing and Recalling Files .....</b>	<b>38</b>
<i>Storing label text .....</i>	38
<i>Recalling text that has been stored .....</i>	39
<i>Deleting text that has been stored .....</i>	39

## **4. Machine Adjustments .....41**

<i>Selecting how tape is fed and cut .....</i>	41
<i>Adjusting the display contrast .....</i>	42
<i>Using the Auto Reduction function .....</i>	42
<i>Calibrating the label length .....</i>	42
<i>Updating the PERSONAL symbol category .....</i>	43
<i>Changing the units of measure .....</i>	43
<i>Displaying version information .....</i>	43
<b>Cleaning .....</b>	<b>44</b>
<i>Cleaning the print head, rollers and tape cutter .....</i>	44

<b>5. Using P-touch Labeller With a Computer .....</b>	<b>46</b>
<i>System requirements .....</i>	<i>47</i>
<i>Installing the P-touch Editor 5.0 and Printer driver .....</i>	<i>47</i>
<i>Uninstalling the P-touch Editor 5.0 .....</i>	<i>51</i>
<i>Uninstalling / Replacing the printer driver .....</i>	<i>52</i>
<b>Using P-touch Editor 5.0 .....</b>	<b>53</b>
<i>Starting P-touch Editor .....</i>	<i>55</i>
<i>Layout window .....</i>	<i>56</i>
<i>Starting P-touch Editor Help .....</i>	<i>58</i>
<b>Transferring Data To/From a Computer .....</b>	<b>60</b>
<i>Entering Transfer mode .....</i>	<i>60</i>
<b>How to use P-touch Transfer Manager &amp; P-touch Library .....</b>	<b>61</b>
<i>Starting up P-touch Transfer Manager .....</i>	<i>61</i>
<i>Transferring label templates from the PC .....</i>	<i>63</i>
<i>Adding a user-defined character image to the text .....</i>	<i>65</i>
<i>Using template data .....</i>	<i>65</i>
<i>Using downloaded database data .....</i>	<i>67</i>
<i>Backing up label templates .....</i>	<i>69</i>
<i>Starting up the P-touch Library .....</i>	<i>71</i>
<i>Searching labels .....</i>	<i>71</i>
<b>6. Appendix .....</b>	<b>73</b>
<b>Resetting the P-touch Labeller .....</b>	<b>73</b>
<b>Troubleshooting .....</b>	<b>73</b>
<b>Error Message List .....</b>	<b>75</b>
<b>Machine Specifications .....</b>	<b>80</b>
<i>Main Unit .....</i>	<i>80</i>
<i>Operating Environment: Windows® .....</i>	<i>82</i>
<b>Accessories .....</b>	<b>82</b>
<b>Index .....</b>	<b>86</b>



# 1 Getting Started

## Unpacking Your P-touch Labeller

Check that the package contains the following before using your P-touch labeller.

P-touch labeller



Rechargeable battery pack (BA-7000)

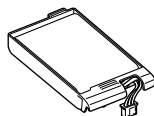

TZ tape cassette

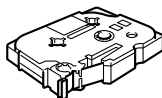

Strap belt

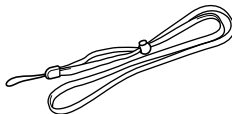

CD-ROM



User's Guide

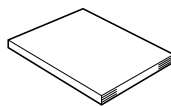

USB cable

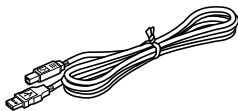

AC adapter (AD-18)



(The design of the adapter may differ by country.)

# General Description

## Top view & bottom view

### Top view

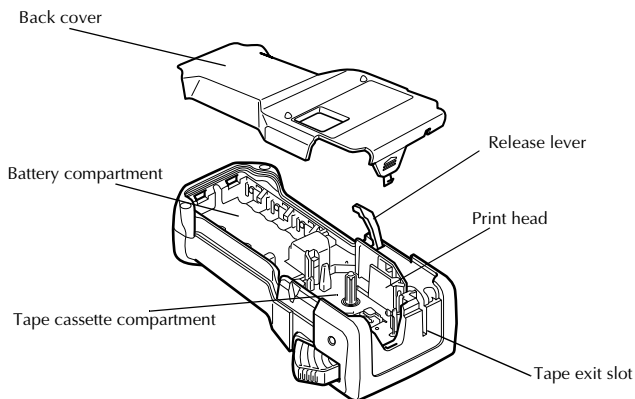
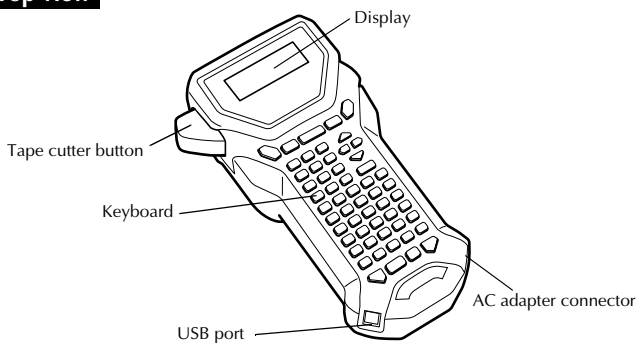

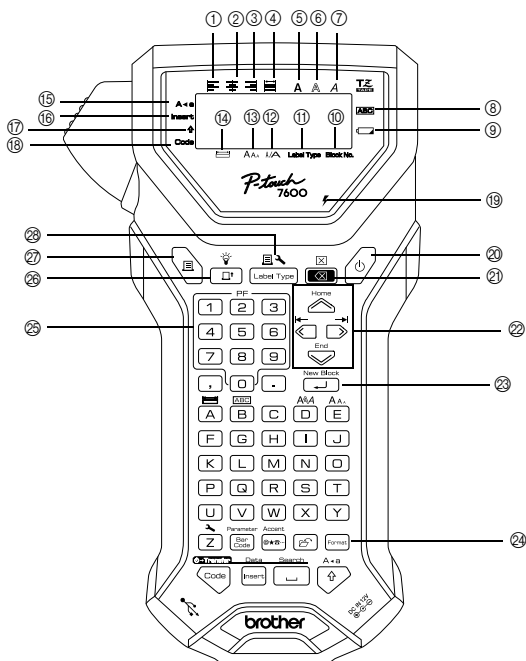

### Bottom view



- |                                      |                                     |
|--------------------------------------|-------------------------------------|
| ① Left text alignment (page 32)      | ⑩ Insert mode (page 20)             |
| ② Center text alignment (page 32)    | ⑪ Shift mode (page 19)              |
| ③ Right text alignment (page 32)     | ⑫ Code mode (page 19)               |
| ④ Justified text alignment (page 32) | ⑬ Charging indicator light (page 7) |
| ⑤ Bold text style (page 31)          | ⑭ Power key (page 11)               |
| ⑥ Outline text style (page 31)       | ⑮ Backspace key (pages 18 & 21)     |
| ⑦ Italic text style (page 31)        | ⑯ Arrow keys (page 18)              |
| ⑧ Frame (page 28)                    | ⑰ Return key (pages 18 & 20)        |
| ⑨ Low battery indicator (page 6)     | ⑱ Global format key (page 29)       |
| ⑩ Block number (page 20)             | ⑲ PF keys (page 32)                 |
| ⑪ Label Type setting (page 12)       | ⑳ Feed key (page 34)                |
| ⑫ Width setting (page 30)            | ㉑ Print key (page 34)               |
| ⑬ Size setting (pages 29 & 30)       | ㉒ Label Type (page 12)              |
| ⑭ Length setting (page 27)           |                                     |
| ⑮ Caps mode (page 19)                |                                     |

## Back light

Press  and  to turn on or turn off the back light. The back light can be used when you wish to see the display more clearly. The default setting is ON.

- ☞ Power can be saved when the back light is turned off.
- ☞ When the back light is turned off, the back light will flash on for about a second when first powering on the machine as a reminder you can use this feature if the display is too hard to see.

## Power Supply

The P-touch labeller can be supplied with power in two or three ways.

	AC adapter (page 4)	Batteries (page 5)	Rechargeable battery pack* (page 6)
PT-7600	●	●	●

\* The rechargeable battery pack is a consumable product. There is no guarantee against its deterioration during storage.

Use the power supply best suited to your needs. For details on each power supply, refer to the following.

## AC Adapter

### Connecting the AC adapter

When printing a large number of labels or labels that contain a large amount of text, it may be useful to connect the P-touch labeller to a standard electrical outlet using the AC adapter.

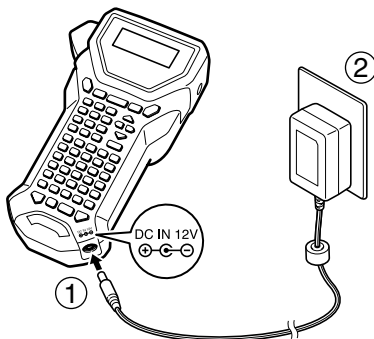



## Notes on the AC adapter

- ☞ Only use the AC adapter designed exclusively for this machine.
- ☞ Disconnect the AC adapter if you do not intend to use this P-touch labeller for an extended period of time. When the power is disconnected and without battery power, all text shown in the display and stored in the memory will be lost.

## Batteries

### Installing the batteries

This machine has been designed to allow you to change the batteries quickly and easily. With batteries installed, this compact and portable machine can be used anywhere.

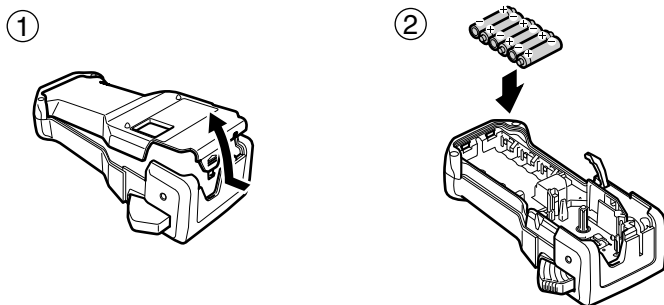

### Notes on batteries

- ☞ **This P-touch labeller requires six AA-size (LR6) batteries. Rechargeable AA-size (Ni-MH) batteries can be used instead of the six alkaline batteries.**
- ☞ The AA-size (Ni-MH) batteries cannot be recharged by leaving them in the P-touch labeller with the AC adapter connected. Instead, recharge these rechargeable batteries by using a battery charger designed specifically for the type or rechargeable batteries used. For more details on the rechargeable batteries, refer to the instructions provided with them.
- ☞ Do not use any of the following, otherwise battery leakage or damage may occur.
  - Manganese batteries
  - A combination of new and used batteries
  - A combination of batteries of different types (alkaline and Ni-MH), different manufacturers or different models
  - A combination of recharged and uncharged batteries

- ☞ Make sure that the batteries are inserted so that their poles point in the correct direction. With batteries installed, the P-touch labeller determines the remaining battery charge during printing and feeding. If a low battery charge is detected, the low battery indicator (  ) comes on. When this occurs, be sure to replace the batteries. The low battery indicator may not come on in some operating conditions.
- ☞ Before replacing the batteries, make sure that the P-touch labeller is turned off. In addition, when replacing the batteries, insert the new ones within two minutes of removing the old ones, otherwise the text shown in the display and any text stored in the memory will be lost.
- ☞ If you do not intend to use this P-touch labeller for an extended period of time, remove the batteries. When the power is disconnected, all text shown in the display and stored in the memory will be lost.

---

## Rechargeable battery pack

---

The machine has a rechargeable battery pack that allows you to use it anywhere when charged, and an AC adapter that allows you to use it while connected to an electrical outlet when the rechargeable battery pack's charge becomes low.

- ☞ If you do not use the rechargeable battery pack frequently, you can increase its useable life by charging it every six months.

---

## Installing the rechargeable battery pack

---

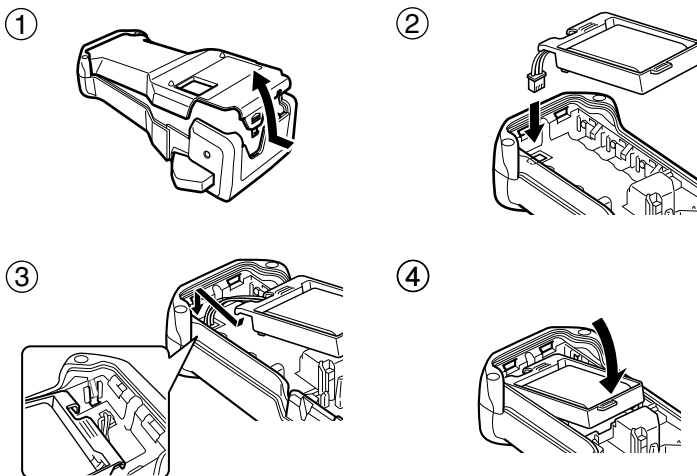

## Charging the rechargeable battery pack

Insert the plug on the AC adapter cord into the connector on the machine and insert the AC adapter plug into a standard electrical outlet. While the rechargeable battery pack is charging, the charging indicator light lights up. Charging time is approx. 3 hours. The charging indicator light turns off when charging is completed.

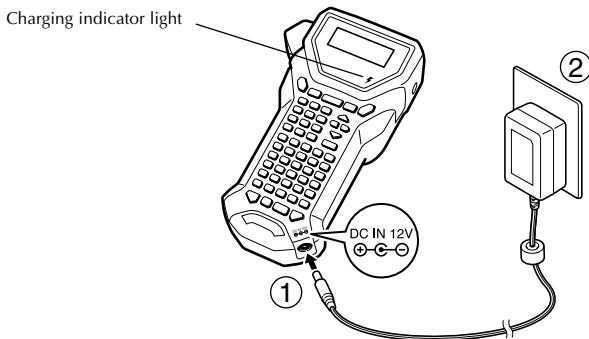

## Replacing the rechargeable battery pack

Replace the rechargeable battery pack when the P-touch labeller can only be used for a short time even after recharging. A fully charged battery pack will continually print one full tape cassette at 25 °C. While the replacement period varies depending on the conditions of use, the rechargeable battery pack will generally need to be replaced after approximately one year. Be sure to replace it with the specified rechargeable battery pack (BA-7000).

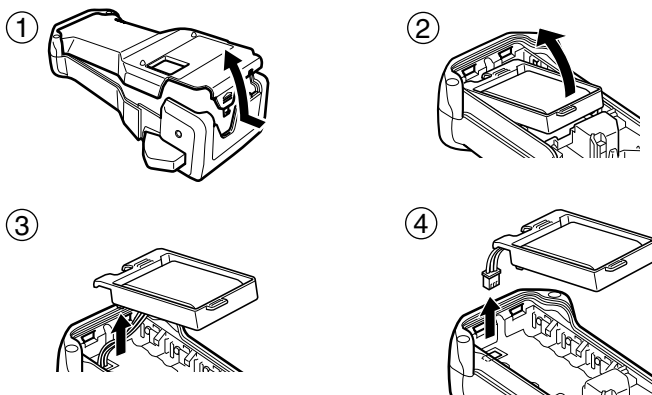

## Notes on the rechargeable battery pack

---

- ☞ Be sure to use the suggested AC adapter (AD-18)
- ☞ Connect the AC adapter directly to the P-touch labeller to use it immediately after purchase or when the rechargeable battery pack's charge becomes low.
- ☞ Disconnect the AC adapter from the P-touch labeller when installing or removing the rechargeable battery pack.
- ☞ Be sure to charge the rechargeable battery pack before using the P-touch labeller.
- ☞ The rechargeable battery pack may not be charged sufficiently when the power supply is less than the rated voltage.
- ☞ Be sure to charge the new rechargeable battery pack for 3 hours after replacement.
- ☞ Be sure to dispose of the expired rechargeable battery pack as directed by local regulations for the disposal of nickel metal hydride batteries.

## Tape Cassettes

### Installing a tape cassette

---

This machine has been designed to allow you to change the tape cassettes quickly and easily. TZ tape cassettes are available for this machine in a wide variety of types, colors and sizes, enabling you to make distinctive color-coded and stylized labels.

①

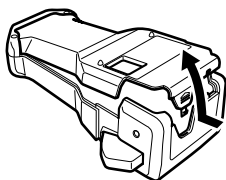

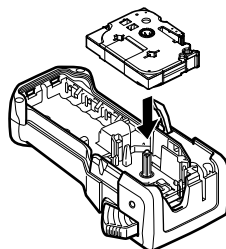

②

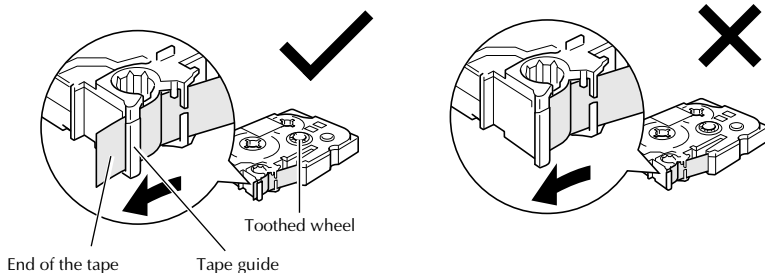

## Notes on tape cassettes

- Before installing the tape cassette, make sure that the end of the tape feeds under the tape guides.
- If the tape cassette to be installed has an ink ribbon and the ink ribbon is loose, use your finger to wind the toothed wheel in the direction of the arrow on the cassette until there is no slack in the ribbon.



- When inserting the tape cassette, make sure that the inner ribbon does not catch on the corner of the metal guide.
- After installing a tape cassette and installing the back cover, press  once to remove any slack in the tape, and then press the tape cutter button to cut off the excess tape.
- Always cut off the tape before removing it from the machine. If the tape is pulled on before being cut off, the tape cassette may be damaged.

## Extra Strength Adhesive Tape

- For textured, rough, or slipping surface, we recommend using Extra Strength Adhesive Tape.
- Although the instruction sheet included with the Extra Strength Adhesive Tape cassette recommends cutting the tape with scissors, the tape cutter that this P-touch labeller is equipped with is able to cut Extra Strength Adhesive Tape.**

## Flexible ID Tape

- For applications that require more flexible labels, such as around sharp bends and cylindrical objects, we recommend using Flexible ID Tape.
- Labels made with Flexible ID Tape are not designed for use as electrical insulation.
- When wrapping labels around cylindrical objects, the diameter of the object should be at least 1/8" (3 mm), otherwise the label should be wrapped as a flag and the **FLAG** Label Type mode should be used. In addition, the overlapping ends of the label or the label flag should be at least 3/16" (5 mm).
- The label may peel off cylindrical objects if the object is bent after the label is affixed.

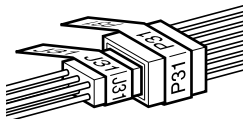
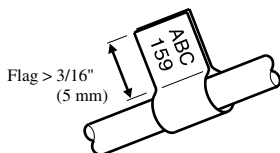
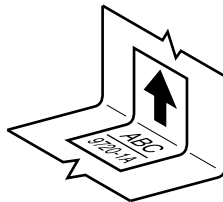
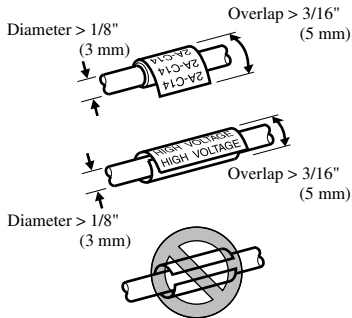

## Turning the P-touch Labeller On/Off







Press  to turn on or turn off the P-touch labeller.

If the P-touch labeller is powered by the AC adapter or batteries, the previous session's text is displayed when the P-touch labeller is turned on again. This feature allows you to stop work on a label, turn off the machine, and return to it later without having to re-enter the text.

Regardless of whether the P-touch labeller is being operated from battery or the AC adapter, the machine will automatically turn off if no key is pressed or no operation is performed for 5 minutes.

## Changing the Language













The language of the menus, settings and messages can be changed by selecting **ENGLISH, FRANÇAIS, ESPAÑOL, PORTUGUÊS, DEUTSCH, NEDERLANDS, ITALIANO, DANSK, SVENSKA, NORSK, or SUOMI**. (The default setting is **ENGLISH**.)

- 1 Press , then .
- 2 Press  or  until **LANGUAGE** is displayed.
- 3 Press  or  until the desired setting is displayed, and then press .

## 2 Label Type Modes

### Selecting a Label Type Mode

Pressing  allows you to select one of the two regular modes for designing and printing your own custom labels, or any of the six special modes available for printing labels pre-formatted for identifying patch panels, cables, connectors and other components.

- 1 Press .
- 2 Press  or  (or continue pressing ) until the desired mode is displayed. (For details on each Label Type mode, refer to the sections below.)
- 3 Press  to apply the selected Label Type mode.
  - If **NORMAL** or **VERTICAL** was selected, continue entering the label text as described in chapter 3, *Basic Functions*.
  - If **ROTATE**, **ROT-REP**, **PORT**, **PANEL1**, **PANEL2** or **FLAG** was selected, continue with the following steps.
- 4 Press  or  until the desired parameter is displayed.
- 5 Press  or  until the desired setting is displayed (or use the number keys to type in the desired setting).
- 6 Press  to apply the selected settings.
- 7 Type the text for each label in a separate text block.
- 8 Print the labels.
  - To print a single copy of each label, press .
  - To print multiple copies or several copies while increasing certain characters, or to print using any other special printing function, press , then  and choose your options. (For details, refer to *Using special printing functions* on page 34.)

### Normal and Vertical Modes

Labels printed using the **Normal** and **Vertical** Label Type modes can be formatted and printed to fit any need.

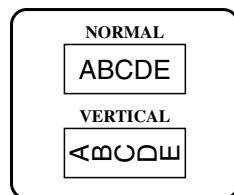



After selecting the Label Type mode **NORMAL** or **VERTICAL**, the label text can be entered, formatted, printed and cut as usual. With the **Normal** Label Type mode, the entered text is printed horizontally along the label. With the **Vertical** Label Type mode, the entered text is printed vertically along the label.

## Rotate and Rotate & Repeat Modes

Labels printed using these Label Type modes can be wrapped around cables and wires to mark them. With both of these modes, the text is rotated 90° counterclockwise and each text block printed on a separate label as shown below. With the Rotate & Repeat mode, the text is printed repeatedly along the length of the label so that it can easily be read from any angle.

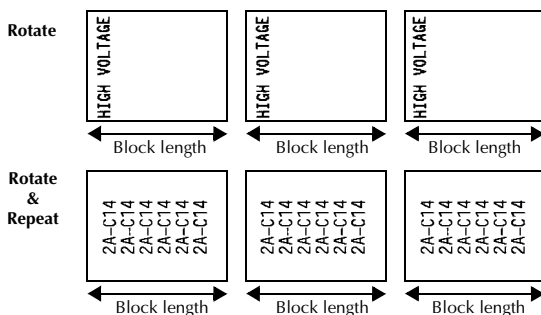
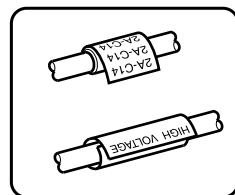

After selecting the **ROTATE** or **ROT-REP** Label Type mode, specify the length of each label and a frame style if desired.

- **BLK LEN.** (block length): 0.80" to 8.00" (20.0 to 200.0 mm)  
Default: 1.20" (30.0 mm)
- **FRAME:** **OFF**,  1,  2,  3,  4  
Default: **OFF**

- ☞ A single block of text can contain a maximum of 7 text lines, and with the **ROT-REP** Label Type mode, only the text lines that fit within the label are printed.
- ☞ For labels to be attached to cables and wires, we recommend using Flexible ID Tape. When wrapping Flexible ID Tape around cylindrical objects, the diameter of the object should be at least 1/8" (3 mm), otherwise the **FLAG** Label Type mode should be used. In addition, the overlapping ends of the label or the flag length should be at least 3/16" (5 mm).

## Flag Mode

Labels printed using this Label Type mode can be wrapped around cable or wire with the ends stuck together to form a flag. With the **FLAG** Label Type mode, each block of text is printed at both ends of separate labels. The length of the unprinted part of this label is equal to the circumference of the cable or wire. In addition, the text can be printed horizontally or rotated 90°.

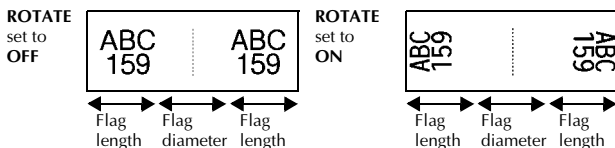
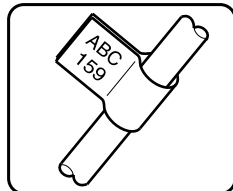

After selecting the **FLAG** Label Type mode, specify the length and diameter of the flag, a frame style if desired, and whether or not to rotate the text.

- **FLAG $\phi$**  (flag diameter): 0.00" to 4.00" (0.0 to 100.0 mm)  
Default: 0.25" (7.0 mm)
- **FLAG LEN** (flag length): 0.40" to 8.00" (10.0 to 200.0 mm)  
Default: 1.20" (30.0 mm)
- **FRAME:** **OFF**,  1,  2,  3,  4  
Default: **OFF**
- **ROTATE:** **OFF**, **ON**  
Default: **OFF**

☞ A single block of text can contain a maximum of 7 text lines.

☞ For labels to be attached to cables and wires, we recommend using Flexible ID Tape. To wrap Flexible ID Tape around cylindrical objects, use the **FLAG** Label Type mode when the diameter of the object is less than 1/8" (3 mm). In addition, the flag length should be at least 3/16" (5 mm).

## Port and Panel1 Modes

Labels printed using these Label Type modes can be used to identify various components or panels.

With the **Port** Label Type mode, each block of the text is printed on a separate label, making these labels useful for identifying different components or ports that are not equally spaced.

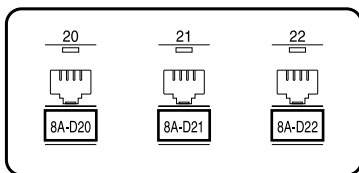

With the **Panel1** Label Type mode, all blocks of the text are evenly spaced on a single label, making this label useful for a row of equally spaced switches, fuses or connectors on a patch panel. In addition, the text blocks can be printed in the order that they were typed in or in the opposite order.

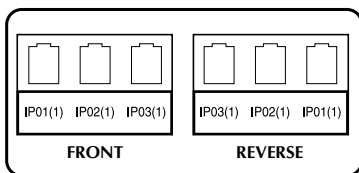

**Port**

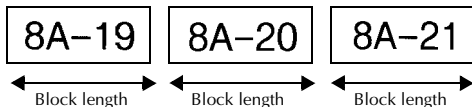

**Panel1**  
(PRINT set to  
**FRONT**)

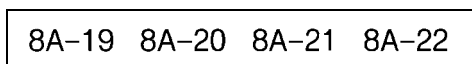

**Panel1**  
(PRINT set  
to **REVERSE**)

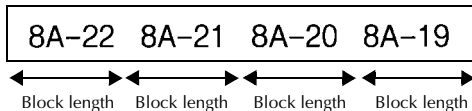

After selecting the **PORT** or **PANEL1** Label Type mode, specify the length of each text block or label, and select a frame style if desired. For the **PANEL1** Label Type mode, select whether the text blocks are printed in the order that they were typed in or in the reverse order.

- **BLK LEN.** (block length): \* For the **PORT** Label Type mode:  
0.80" to 8.00" (20.0 to 200.0 mm)  
Default: 1.20" (30.0 mm)  
\* For the **PANEL1** Label Type mode:  
0.25" to 8.00" (6.0 to 200.0 mm)  
Default: 1.20" (30.0 mm)
- **FRAME:** \* For the **PORT** Label Type mode:  
**OFF**,  1,  2,  3,  4  
Default: **OFF**  
\* For the **PANEL1** Label Type mode:  
**OFF**, 1 | | | , 2 | | | , 3 | | | ,  
4  , 5  , 6  ,  
7  , 8  , 9   
Default: **OFF**
- **PRINT** (print order): **FRONT, REVERSE**  
Default: **FRONT**

For these types of labels, we recommend using Extra Strength Adhesive Tape.  
The **PRINT** parameter is only available with the **PANEL1** Label Type mode.  
By using the Numbering function with the **PANEL1** Label Type mode, a single label containing multiple blocks of ascending characters can easily be created, for example, to label patch panels as shown above. (For details on the Numbering function, refer to *Printing multiple copies with incremental characters* on page 35.)

## Panel2 Mode

Specifying a fixed length for each block makes this label useful for a row of switches (for example, in a switchboard) or a patch panel. In addition, the text blocks can be printed in the order that they were typed in or in the opposite order, or the text can be printed rotated 90°.

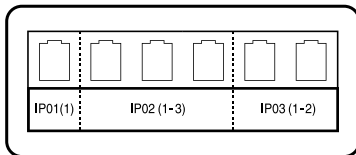

Panel2

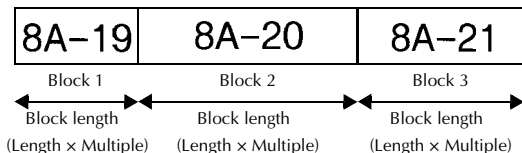







# 3 *Basic Functions*

## Performing Basic Operations

### Choosing functions, parameters, settings and groups

- If “◀▶” appears, press  to select the previous item or  to select the next item.
- If “◀▶” appears, press  to select the previous item or  to select the next item.

### Choosing the default setting

- To select the default setting of a function or parameter, press .

### Confirming a choice

- To select an item from a list, to apply a selected setting, or to answer “yes”, press .



### Cancelling a choice



- To quit a function and return to the previous display without changing the text, or to answer “no”, press .



# Inputting Label Data



## Entering and editing text

### Entering characters

- To type a lowercase letter, a number, a comma or a period, simply press the key for that character.
- To type an uppercase letter, press  to enter Shift mode, and then press the applicable letter.
- To type uppercase letters continuously, press , then  to enter Caps mode, and then type.

 To exit Shift mode without typing a letter, press .

 To exit Caps mode, press , then .













 To type a lowercase letter in Caps mode, press , then the applicable letter.





### Entering spaces

- To add a blank space to the text, press .

### Moving the cursor

Move the cursor in order to review and edit the text, or you can select the various functions and settings.

- To move the cursor left, right, up or down, press , ,  or .
- To move the cursor to the beginning of the current line of text, press , then .
- To move the cursor to the end of the current line of text, press , then .
- To move the cursor to the beginning of the entered text, press , then .
- To move the cursor to the end of the entered text, press , then .

 To move the cursor several characters or lines at once, hold down , ,  or .

## Adding a new line of text



- To end the current line of text and start a new one, press . “↵” appears at the end of the line.

The number of text lines that can be printed depends on the width of the tape.

Tape Width	Maximum Number of Lines That Can Be Printed
1/4" (6 mm)	2
3/8" (9 mm)	2
1/2" (12 mm)	3
3/4" (18 mm)	5
1" (24 mm)	7

The line number on the display indicates the line number of the text block.

## Adding a new text block

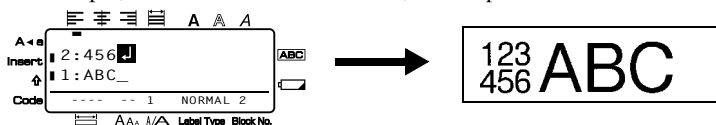

- To create a new text block so that one section of the text can have a different number of lines than another, press , then . “↵” appears at the end of the block.

For example, text entered as shown below, will be printed as follows.









- A single label can only contain a maximum of fifty text blocks.
- The number of the block that the cursor is in is indicated at the bottom of the display.
- All text blocks have the same formatting features.
- While trying to print a large amount of data at one time, some outputted labels may be blank. For example, when printing 50 records, the maximum number of characters that can be printed at one time is limited to approximately 200.

## Inserting text

- To insert the text that you type at the cursor's current position, make sure that the **Insert** indicator is displayed. Otherwise, press  to enter **Insert** mode.
- To replace the text at the cursor's current position instead of inserting it, press  to exit **Insert** mode.



## Deleting text





- To remove characters to the left of the cursor's current position, press  until all of the characters that you wish to delete are removed.
- To delete all of the text:
  - Press , then .
  - Press  or  to select either **TEXT ONLY** (to erase just the text) or **TEXT&FORMAT** (to erase all of the text and return all formatting functions to their default settings).
  - Press .

## Entering an accented character

There are various accented characters available with the Accent function.



The following accented characters are available.

Character	Accented Characters	Character	Accented Characters
a	á à â ã ä å ã ä å ã	n	ñ ñ ñ ñ
A	Á Â Ã Ä Å Æ Ā Ā Ā Ā Ā	N	Ñ Ñ Ñ Ñ
c	ç ċ é	o	ó ô õ ø ö õ œ ö
C	Ç Ć Ć	O	Ó Ô Õ Ø Ö Õ Œ Ö
d	ď ð đ	r	ř ř ř
D	Ď Đ	R	Ř Ř Ř
e	é è ê ë ě é é é	s	ś ś ś ś β
E	É È Ê Ë Ě Ě Ě Ě	S	Ś Ś Ś Ś β
g	ğ ğ	t	ť ť þ
G	Ğ Ğ	T	Ť Ť Þ
i	í î ï ĳ ĵ Ķ	u	ú û ü ü ü ü ü
I	Í Î Ï Ĵ Ķ	U	Ú Û Ü Ü Ü Ü Ü
k	ķ	y	ý ŷ
K	Ķ	Y	Ý Ŷ
l	ł ł ł ł	z	ž ź ź
L	Ł Ł Ł Ł	Z	Ž Ž Ž

- Press , then . The message "ACCENT a-z/A-Z?" appears.
- Press the key corresponding with the desired accented character repeatedly, until the correct character is displayed.
- Add the accented character(s) to the text.
  - To add a single accented character or the last one in a series, skip to step **5**.
  - To add a series of accented characters to the text, press , then .

4 For each additional accented character, repeat steps 2 and 3.

5 Press .

☞ To type in an uppercase accented character, press  (or press , then  to enter Caps mode) before pressing the letter key.

## Entering a bar code

The **Bar Code** function allows bar codes to be printed as part of labels.







- ☞ Since this machine is not specifically designed for special bar code label-making, some bar code readers may not be able to read the labels.
- ☞ Bar code readers may not be able to read bar codes printed with certain ink colors on certain label tape colors. For best results, print bar code labels using black on white tape.

In addition, the various bar code parameters enable you to create more customized bar codes.



Parameter	Settings
<b>PROTOCOL</b>	<b>CODE 39, I-2/5, EAN13, EAN8, UPC-A, UPC-E, CODABAR, EAN128, CODE128</b>
<b>WIDTH</b> (bar width)	<b>SMALL, MEDIUM, LARGE</b>
<b>UNDER#</b> (numbers printed below bar code)	<b>ON, OFF</b>
<b>CHECK DIGIT</b>	<b>OFF, ON</b>





☞ The **CHECK DIGIT** parameter is only available with the **CODE 39, I-2/5** and **CODABAR** protocols.





## Setting bar code parameters

- 1 Press , then .
- 2 Press  or  until the parameter that you wish to change is displayed.
- 3 Press  or  until the desired setting is displayed.
- 4 Repeat steps 2 and 3 until all parameters are set as you wish.
- 5 Press .

## Entering bar code data

- 1 Press .
- 2 Type in the new bar code data or edit the old data.
- 3 Press  to add the bar code to the text.

 To add special characters to the bar code data (only with protocols **CODE39**, **CODABAR**, **EAN128** or **CODE128**), position the cursor below the character immediately to the right of where you wish to add the special character, and then press . Press  or  until the desired control character is displayed, and then press  to add the character to the data. (Refer to the tables below for a list of the special characters that are available.)

 To change the data or **WIDTH** or **UNDER#** parameter settings of a bar code that has already been added to the text, position the cursor below the bar code mark (  ), and then press , then .

The following control characters can only be added to bar codes created using protocol **CODE39** or **CODABAR**.

**CODE39**

**CODABAR**

Symbol	Character	Symbol	Character
0	-	4	/
1	.	5	+
2	(SPACE)	6	%
3	\$		

Symbol	Character	Symbol	Character
0	-	3	/
1	\$	4	.
2	:	5	+





The following special characters can only be added to bar codes created using protocols **EAN128** and **CODE128**.



Symbol	Character	Symbol	Character	Symbol	Character
0	(SPACE)	10	★	20	>
1	!	11	+	21	?
2	"	12	/	22	@
3	#	13	-	23	[
4	\$	14	.	24	\
5	%	15	/	25	]
6	&	16	:	26	^
7	'	17	;	27	_
8	(	18	<		
9	)	19	=		

Symbol	Control Character	Symbol	Control Character	Symbol	Control Character
28	NUL	42	CR	56	ESC
29	`	43	SO	57	{
30	SOH	44	SI	58	FS
31	STX	45	DLE	59	
32	ETX	46	DC1	60	GS
33	EOT	47	DC2	61	}
34	ENQ	48	DC3	62	RS
35	ACK	49	DC4	63	~
36	BEL	50	NAK	64	US
37	BS	51	SYN	65	DEL
38	HT	52	ETB	66	FNC3
39	LF	53	CAN	67	FNC2
40	VT	54	EM	68	FNC4
41	FF	55	SUB	69	FNC1

## Entering a symbol



There are 164 symbols and pictures available with the Symbol function.



- 1 Press . The last category used is displayed.
- 2 Press  or  to select the desired category.
- 3 Press  or  until the desired symbol is selected.
- 4 Add the symbol(s) to the text.

- To add a single symbol or the last one in a series, skip to step 6.
- To add a series of symbols to the text, press , then .



5 For each additional symbol, repeat steps 2 through 4.

6 Press .

 A symbol can also be selected by typing in the corresponding code from the table below. For example, typing “A02”, then pressing  adds “?” to the text.

 Some symbols are printed in color on the keypad. To use a symbol on a key, press  to enter Code mode, and then press the key for the symbol.

The following symbols are available.

Category	Symbols									
<b>A</b> PUNCTUATION	.	,	?	!	“	’	:	;	—	—
	00	01	02	03	04	05	06	07	08	09
	\	/	&	¿	¡	~	§	▪		
	10	11	12	13	14	15	16	17		
<b>B</b> BUSINESS	@	#	%	®	©	™				
	00	01	02	03	04	05				
<b>C</b> MATHEMATICS	+	-	×	*	±	=	÷			
	00	01	02	03	04	05	06			
<b>D</b> BRACKET	(	)	[	]	<	>	«	»		
	00	01	02	03	04	05	06	07		
<b>E</b> ARROW	→	←	↑	↓	➔	➔	⬆	⬇		
	00	01	02	03	04	05	06	07	08	09
<b>F</b> UNIT	°	\$	¥	£	€	¢	f	φ		
	00	01	02	03	04	05	06	07		
<b>G</b> INTERNATIONAL CHARACTERS	á	â	ß	š	à	â	γ	δ	μ	Ω
	00	01	02	03	04	05	06	07	08	09
	Đ	ð	Þ	þ	ij					
	10	11	12	13	14					

Category		Symbols									
<b>H</b>	NUMBER	1/2	1/3	1/4	0	1	2	1	2		
		00	01	02	03	04	05	06	07		
<b>I</b>	PICTOGRAPH	★	○	●	□	△	◆				
		00	01	02	03	04	05				
<b>J</b>	ELECTRICAL / ELECTRONIC										
		00	01	02	03	04	05	06	07	08	09
		10	11	12	13	14	15	16	17	18	19
		20	21	22	23	24	25	26	27	28	29
		30	31	32	33	34	35	36	37	38	39
40	41	42									
<b>K</b>	PROHIBITION										
		00	01	02							
<b>L</b>	WARNING										
		00	01	02	03	04	05	06			
<b>M</b>	COMMUNICATIONS										
		00	01	02	03	04	05				
<b>N</b>	AUDIO/VISUAL										
		00	01	02	03	04	05	06	07	08	09
10	11	12	13	14							

Category	Symbols			
<b>O</b> OTHERS				
	00	01	02	03
<b>Z</b> PERSONAL CATEGORY	*A maximum of 16 most recently selected symbols are automatically saved in the <b>PERSONAL</b> symbol category for quick and easy symbol use.			

☞ Once the **PERSONAL** symbol category becomes full, newly selected symbols will overwrite older ones unless the Symbol Save function is set to **OFF**. (Refer to *Updating the PERSONAL symbol category* on page 43.)

## Formatting the Label

### Specifying a label length

The length of the label can be specified as follows.

- 1 Press , then .
- 2 Press or until **LENGTH** is displayed.
- 3 Press or until the desired label length is displayed (or use the number keys to type in the desired setting).
- 4 Press .

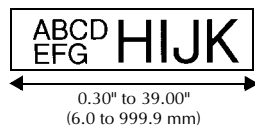



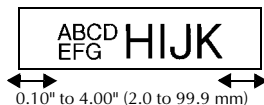

### Specifying a margin size

The size of the margins for the left and right sides of the text can be specified.















- 1 Press , then .
- 2 Press or until **MARGIN** is displayed.
- 3 Press or until the desired margin setting is displayed (or use the number keys to type in the desired margin setting).
- 4 Press .



## Framing the text

- 1 Press , then .
- 2 Press  or  until the desired frame setting is displayed.
- 3 Press . The selected setting is applied to the entire text.

The following frame styles are available.

Frame Setting	Sample	Frame Setting	Sample
1		8	
2		9	
3		10	
4		11	
5		12	
6		13	
7		14	









## Specifying the character size





The character size can be specified for all text in the label or only for the text in the line that the cursor is in.

☞ With the default character size setting **AUTO**, the largest possible text size is automatically selected depending on the width of the installed tape and the number of lines in the text.

## Formatting the Global character size of all text

- 1 Press .
- 2 Press  or  until **GLB SIZE** is displayed.
- 3 Press  or  until the desired character size setting is displayed.
- 4 Press . The selected setting is applied to the entire text.

## Formatting the character size of a line

- 1 Move the cursor to the line of text whose size you wish to change.
- 2 Press , then .
- 3 Press  or  until the desired character size setting is displayed.
- 4 Press . The selected setting is only applied to the text line that the cursor is positioned in.







☞ Since the text sizes that can be printed depends on the width of the tape, the following table shows the maximum text size that can be used with each tape width.

Tape Width	Maximum Text Size
1/4" (6 mm)	12 points
3/8" (9 mm)	18 points
1/2" (12 mm)	24 points
3/4" (18 mm)	36 points
1" (24 mm)	48 points







☞ With the **AUTO** setting selected and the text in a block consisting of just one line of only uppercase letters (and no accented letters), the text is printed slightly larger than the maximum possible for the tape width.

## Specifying the character width

### Formatting the Global width of all text

- 1 Press .
- 2 Press  or  until **GLB WIDTH** is displayed.
- 3 Press  or  until the desired character width setting is displayed.
- 4 Press . The selected setting is applied to the entire text.

### Formatting the width of a line

- 1 Move the cursor to the line of text whose character width you wish to change.
- 2 Press , then .
- 3 Press  or  until **WIDTH** is displayed.
- 4 Press  or  until the desired character width setting is displayed.
- 5 Press . The selected setting is only applied to the text line that the cursor is positioned in.







The following width sizes are available for each text size as shown.

Width Size	NORMAL	NARROW	MINIMUM	WIDE
48 points	ABC	ABC	ABC	ABC
36 points	ABC	ABC	ABC	ABC
24 points	ABC	ABC	ABC	ABC
18 points	ABC	ABC	ABC	ABC
12 points	ABC	ABC	ABC	ABC
9 points	ABC	ABC	ABC	ABC





Width Size	NORMAL	NARROW	MINIMUM	WIDE
6 points	ABC	ABC	ABC	ABC

## Specifying the character style

### Formatting the Global character style of all text

- 1 Press .
- 2 Press  or  until **GLB STYL** is displayed.
- 3 Press  or  until the desired character style setting is displayed.
- 4 Press . The selected setting is applied to the entire text.







### Formatting the character style of a line

- 1 Move the cursor to the line of text whose character style you wish to change.
- 2 Press , then .
- 3 Press  or  until the desired character style setting is displayed.
- 4 Press . The selected setting is only applied to the text line that the cursor is positioned in.

The following text styles are available.

Style Setting	Sample	Style Setting	Sample
NORMAL	ABC	ITALIC	<i>ABC</i>
BOLD	<b>ABC</b>	<b>I+BOLD</b> (italic & bold)	<b><i>ABC</i></b>
OUTLINE	ABC	<b>I+OUTL</b> (italic & outline)	<b><i>ABC</i></b>

## Specifying the alignment for all lines in the text

- 1 Press .
- 2 Press  or  until **ALIGN** is displayed.
- 3 Press  or  until the desired setting is displayed.
- 4 Press . The selected setting is applied to the entire text.





The following alignment settings are available.

ABC DEFGH IJKLM	ABC DEFGH IJKLM	ABC DEFGH IJKLM	A B C DEFGH IJKLM
<b>LEFT</b>	<b>CENTER</b>	<b>RIGHT</b>	<b>JUSTIFY</b>

## Using the pre-formatted Auto Format templates

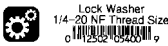
Various pre-formatted label templates are available, enabling you to quickly and easily create labels for a variety of applications—from identifying the contents of boxes and file folders to labelling equipment and making name badges and ID tags. After simply selecting one of the ten label templates, type text into each of its fields, and then the label is ready to be printed.

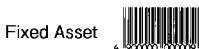
The following label templates are available.

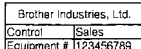
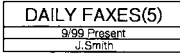
Key	Template Name	Tape Width × Label Length	Template Fields	Sample
1	<b>BIN BOX</b>	3/4" × 2.80" (18 mm × 70 mm)	① SYMBOL? ② TEXT1? ③ TEXT2? ④ BAR CODE?	
2	<b>ASSET1</b>	1" × 3.35" (24 mm × 84 mm)	① TEXT1? ② TEXT2? ③ BAR CODE?	
3	<b>ASSET2</b>	1" × 3.15" 24 mm × 80 mm	① TEXT? ② BAR CODE?	
4	<b>ASSET3</b>	1" × 1.65" (24 mm × 41 mm)	① TEXT? ② BAR CODE?	
5	<b>ASSET4</b>	1" × 2.25" (24 mm × 56 mm)	① TEXT1? ② TEXT2? ③ TEXT3? ④ TEXT4? ⑤ TEXT5?	
6	<b>ID LABEL</b>	1" × 2.80" (24 mm × 70 mm)	① TEXT1? ② TEXT2? ③ TEXT3?	

Key	Template Name	Tape Width × Label Length	Template Fields	Sample
	<b>SIGN</b>	1" × 4.05" (24 mm × 102 mm)	① SYMBOL? ② TEXT1? ③ TEXT2?	<b>NO SMOKING</b>
	<b>BADGE</b>	3/4" × 4.05" (18 mm × 102 mm)	① NAME? ② COMPANY?	<b>Robert Becker</b> ABC Transport
	<b>FILING</b>	1/2" × 3.55" (12 mm × 89 mm)	① TITLE? ② SUBTITLE?	<b>August Sales Report</b> Overseas Sales Div.
	<b>IC CHIP</b>	3/8" × 1.05" (9 mm × 26 mm)	① TEXT1? ② TEXT2?	01234567 ver 1.1"

- Press , then the number key where the template that you wish to use is assigned.
- Press . The first field for the selected template is displayed.
- Press or to display each field, and then type in the text.
- To print a single copy, press .
  - To print multiple copies, several copies while increasing certain characters, or a mirror image of the text, press , then . (For details, refer to *Using special printing functions* on page 34.)

ⓘ TZ tapes have not been tested for electrostatic discharge.

ⓘ Accented characters (page 21), symbols (page 24) and bar codes (page 22) can be entered in the template fields.

ⓘ To quit using the template, display the last field, and then press . The Auto Format menu appears. Press or until **EXIT** appears, and then press .

## Printing Labels

### Previewing the label layout

The **Preview** function allows you to see a sample of the layout of the text.



- To use the print preview, press , then . The length of the current label is indicated in the lower-left corner of the display.

ⓘ To scroll the print preview left or right, press or .

ⓘ To return to the text, press or .

## Feeding tape



- To feed out 1" (23 mm) of tape, press . The message "FEED" is displayed.

Press  to feed out any leftover printed tape after pressing  to quit printing.

## Printing a label

- To print out a label, press . The message "WORKING", then "COPIES" followed by the number of the label being printed is displayed.

To quit printing, press  to turn off the P-touch labeller.











When setting **3** (cut pause; chain printing) or **4** (no cut pause; chain printing) is selected in the Cut function (page 41), "OK TO FEED?" will appear. Press  to feed. Or press  to return the entering text mode.

## Using special printing functions



Various special printing functions are available that enable you to print multiple copies of labels, print several copies while incrementing the values of certain characters, print specific sections of label text, or print label text as a mirror image.

### Printing multiple copies of a label

The Repeat Printing function allows you to print up to 99 copies of the same text.

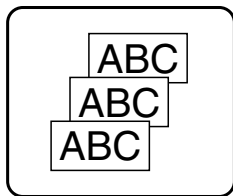
- 1 Press , then .
- 2 Press  or  until **COPIES** is displayed.
- 3 Press  or  until the desired number of copies is displayed (or use the number keys to type in the desired setting).
- 4 Press  (or ). **START** appears in the Print Option menu.
- 5 Press  (or ) to begin printing the specified number of copies. The number of each copy is displayed while it is being printed.









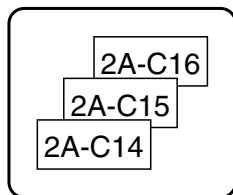















- ☞ If the Cut function is set to **1** or **3**, the message “CUT TAPE TO CONTINUE” appears after each label is printed. Press the tape cutter button to cut off the label and continue printing.
- ☞ Be sure to cut the tape within 5 minutes from the time that the message appears.
- ☞ For the different options available for cutting the tape, refer to *Selecting how tape is fed and cut* on page 41.
- ☞ To specify settings for additional Print Option functions, instead of continuing with step **5**, press  or  until **CONTINUE** is displayed in the Print Option menu, and then press .

## Printing multiple copies with incremental characters

The Numbering function can be used to print several copies of the same text while incrementing the values of certain characters (letters, numbers or bar code data) after each label is printed. This type of automatic incrementation is very useful when printing serial number labels, production control labels or other labels requiring ascending codes.









- 1** Press , then .
- 2** Press  or  until **NUMBER** is displayed.
- 3** Press  or  until the desired number of copies is displayed (or use the number keys to type in the desired setting).
- 4** Press . The message “START?” appears. (To specify only the character at the cursor’s current position as the numbering field, press , and then skip to step **9**.)
- 5** Press , ,  or  until the first character that you wish to include in the numbering field is flashing.
- 6** Press . The message “END?” appears.
- 7** Press , ,  or  until the last character that you wish to include in the numbering field is flashing.
- 8** Press . **START** appears in the Print Option menu.
- 9** Press  (or ) to begin printing the specified number of labels. The number of each copy is displayed while it is being printed.

- ☞ If the Cut function is set to **1** or **3**, the message “CUT TAPE TO CONTINUE” appears after each label is printed. Press the tape cutter button to cut off the label and continue printing.
- ☞ Be sure to cut the tape within 5 minutes from the time that the message appears.
- ☞ For the different options available for cutting the tape, refer to *Selecting how tape is fed and cut* on page 41.
- ☞ Letters and numbers increase as shown below.  
 0 → 1 → ...9 → 0 → ...  
 A → B → ...Z → A → ...  
 a → b → ...z → a → ...  
 A0 → A1 → ...A9 → B0 → ...  
 Spaces (shown as underlines “\_” in the examples below) can be used to adjust the space between characters or to control the number of digits that are printed.  
 \_Z → AA → ...ZZ → AA → ...  
 \_9 → 10 → ...99 → 00 → ...  
 1\_9 → 2\_0 → ...9\_9 → 0\_0 → ...
- ☞ Only one numbering field can be selected from any text.
- ☞ A numbering field must be located entirely within one line of text of a single block.
- ☞ A maximum of five characters can be selected for the numbering field.
- ☞ If you include a non-alphanumeric character such as a symbol in the numbering field, only the letters and numbers in the numbering field will be increased when the labels are printed, or just one label will be printed if the field only contains a non-alphanumeric character.
- ☞ To specify settings for additional Print Option functions, instead of continuing with step 9, press  or  until **CONTINUE** is displayed in the Print Option menu, and then press .
- ☞ If a bar code is selected as the numbering field in step 5, skip steps 6 and 7, and continue with step 8.





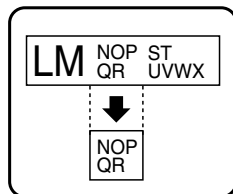

## Printing a range of text blocks



The Block Printing function enables you to select the range of text blocks to print.

- 1 Press , then .
- 2 Press  or  until the first number in the range displayed below **BLOCK NO.** is flashing.
- 3 Press  or  until the desired block number is displayed (or use the number keys to type in the desired setting).













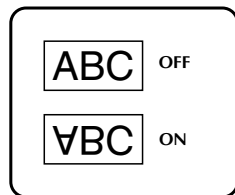

- ④ Press  so that the second number in the range displayed below **BLOCK NO.** is flashing.
- ⑤ Press  or  until the desired block number is displayed (or use the number keys to type in the desired setting).
- ⑥ Press  (or ). **START** appears in the Print Option menu.
- ⑦ Press  (or ) to begin printing the specified number of labels. The number of each copy is displayed while it is being printed.

☞ To specify settings for additional Print Option functions, instead of continuing with step ⑦, press  or  until **CONTINUE** is displayed in the Print Option menu, and then press .



## Printing mirrored labels

This function prints your label so that the text can be read from the adhesive side of the tape. If mirror-printed labels are attached to glass or some other transparent material, they can be read correctly from the opposite side.



- ① Press , then .
- ② Press  or  until **MIRROR** is displayed.
- ③ Press  or  until **ON** is displayed.
- ④ Press  (or ). **START** appears in the Print Option menu.
- ⑤ Press  (or ) to begin printing the specified number of labels. The number of each copy is displayed while it is being printed.

☞ When using the Mirror Printing function, the text should be printed on clear tape.

☞ To specify settings for additional Print Option functions, instead of continuing with step ⑤, press  or  until **CONTINUE** is displayed in the Print Option menu, and then press .

## Combining special printing functions

Many of the special printing functions can be combined, depending on various conditions, such as which Label Type mode is selected or whether a template is being used. For example, by combining the operations for the Repeat Printing function and the Numbering function to print two copies of a label with “1” selected as the numbering field and three increments, the labels shown above will be printed.

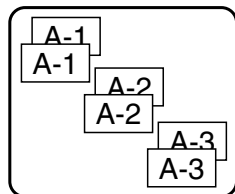







For details on the various special printing functions, refer to the corresponding section above.



## Storing and Recalling Files

Frequently used label text along with its formatting can be stored in the memory and easily recalled so that it can be edited and quickly printed. When each text file is stored, it is given a number to make recalling it easier. Up to 10 text files or approximately 2,000 characters can be stored in the memory.







Since a copy of the stored text file is recalled when the Recall function is used, the text can be edited or printed without changing the originally stored file. When a file is no longer needed or more space is necessary, the Clear function can be used to delete text files.



### Storing label text

- 1 Press .
- 2 Press  or  until **STORE** is displayed.
- 3 Press .
- 4 Press  or  until the file number where you wish to store the text is displayed.
- 5 Press .











- ☞ If the maximum number of characters has already been stored, the error message “MEMORY FULL!” appears in the display. If this occurs, an existing text file must be deleted before the new one can be stored.
- ☞ If a file is already stored under the selected file number, the message “OVERWRITE?” appears in the display. To overwrite the stored file with the new one, press . To go back and choose another file number without overwriting the text file, press , and then select a different file number.

## Recalling text that has been stored

- 1 Press .
- 2 Press  or  until **RECALL** is displayed.
- 3 Press .
- 4 Press  or  until the file number containing the text that you wish to recall is displayed.
- 5 Press . Any text previously entered in the display is erased and the text stored under the selected file number is recalled into the display.



- ☞ To view other parts of the selected text file, press  or .

## Deleting text that has been stored



- 1 Press .
- 2 Press  or  until **CLEAR** is displayed.
- 3 Press .
- 4 Press  or  until the file number containing the text that you wish to delete is displayed.
- 5 Select the file(s) to be deleted.
  - To delete a single file, skip to step 6.
  - To select multiple files, press . The current file number is highlighted. Continue selecting text files by repeating step 4, then pressing  until all files that you wish to delete are selected.
  - To delete all files, press , then .

6 Press . The message “OK TO CLEAR?” (or “CLEAR ALL?” if all files were selected) appears.

7 Press . The text stored in the selected files is deleted.

 If you do not wish to delete the selected text file(s), press  instead of  in step 7.

 To view other parts of the selected text file, press  or .

 To remove a text file from those that are to be deleted, display the text file, and then press  so that the file number is no longer highlighted.

# 4 Machine Adjustments

Various functions are available for changing and adjusting the operation of the P-touch labeller.







## Selecting how tape is fed and cut

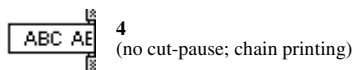
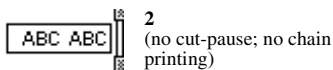
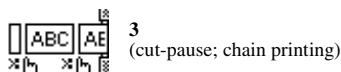
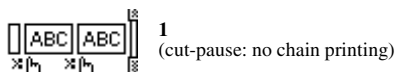

The **Cut** function enables you to specify how the tape is fed out after it is printed. The settings of the Cut function consist of combinations of two different cut methods: **cut-pause** (where the machine stops printing so the label can be cut) and chain printing (where the last copy is not fed out to be cut, reducing the amount of tape that is wasted).

**Chain printing is an economical function designed to help eliminate “wasted tape” at the beginning of labels.** Without chain printing, the excess from the previous printing session is cut before the first label in the current session is printed. However, if a setting using chain printing is selected, the last label in the previous session remains in the machine (is not fed out), so that the next label can be printed without wasting tape. When the last label is printed, press  to feed the chain of labels, and then press the tape cutter button to cut it.

The following settings are available: (The default setting is 1.)



- 1 Press , then .
- 2 Press  or  until **CUT** is displayed.
- 3 Press  or  until the desired setting is displayed, and then press .







After printing with the **Cut** function set to 3 or 4, “OK TO FEED?” will appear. Press  to feed. Press  to return the entering text mode.

---

## Adjusting the display contrast

---

The display can be made lighter or darker by selecting a setting between **-2** and **+2**. (The default setting is **0**.) Select a higher value to increase the contrast (make the display darker). Select a lower value to decrease the contrast (make the display lighter).







- 1 Press , then .
- 2 Press  or  until **CONTRAST** is displayed.
- 3 Press  or  until the desired setting is displayed, and then press .

---

## Using the Auto Reduction function

---

With the Auto Reduction function, you can select whether the text width (**TEXT WIDTH**) or the text size (**TEXT SIZE**) will be reduced if text that is set to the **AUTO** Size setting is too large for the specified label length. (The default setting is **TEXT SIZE**.)

- 1 Press , then .
- 2 Press  or  until **AUTO REDUCTION** is displayed.
- 3 Press  or  until the desired setting is displayed, and then press .

If **TEXT SIZE** is selected and more text is added, the character size is reduced so the text fits within the specified label length.



If **TEXT WIDTH** is selected and more text is added, the character width is reduced so the text fits within the specified label length.

However, after the character width is reduced to **MINIMUM**, the character size will be reduced so the text fits within the specified label length.

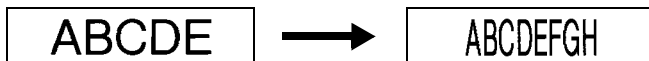







---

## Calibrating the label length

---

If the length of the printed label does not correspond to the length specified with the Length function, the printed label length can be recalibrated with the Length Adjust function by selecting a setting between **-5** and **+5**. (The default setting is **0**.)







- 1 Press , then .
- 2 Press  or  until **LENGTH ADJUST** is displayed.
- 3 Press  or  until the desired setting is displayed, and then press .

---

## Updating the PERSONAL symbol category

---

You can specify whether symbols continue to be added to the **PERSONAL** symbol category (with the older symbols deleted) when the category becomes full (**ON**) or symbols are no longer added after the **PERSONAL** symbol category becomes full (**OFF**). (The default setting is **ON**.)







- 1 Press , then .
- 2 Press  or  until **SYMBOL SAVE** is displayed.
- 3 Press  or  until the desired setting is displayed, and then press .

---

## Changing the units of measure

---

The units used for displaying measurements can be set to millimeters (**mm**) or inches (**inch**). (The default setting is **inch**.)







- 1 Press , then .
- 2 Press  or  until **UNITS** is displayed.
- 3 Press  or  until the desired setting is displayed, and then press .

---

## Displaying version information

---

This function can be used to display the version information for the P-touch labeller software and built-in symbol set.

- 1 Press , then .
- 2 Press  or  until **VERSION INFO** is displayed.
- 3 Press  or  until the desired version information is displayed.
- 4 Press  to exit Setup mode.

## Cleaning

Occasionally, certain parts of the P-touch labeller may need to be cleaned. Dust or dirt may become attached to the P-touch labeller's print head and rollers, particularly when the unit is used outdoors or in a very dusty environment. With use, the tape cutter may become covered with adhesive, making it difficult to cut the tape.

### Cleaning the print head, rollers and tape cutter

- ⓘ Before cleaning the print head, rollers and tape cutter, press  to turn off the P-touch labeller, and then remove the battery and disconnect the AC adapter.
- ⓘ When power is disconnected for more than two minutes, all text and format settings will be cleared. Any text files stored in the memory will also be cleared.

#### WARNING

- Do not touch the print head directly with your bare hands. The print head may be hot.
- Do not touch the cutter blade directly with your bare hands.

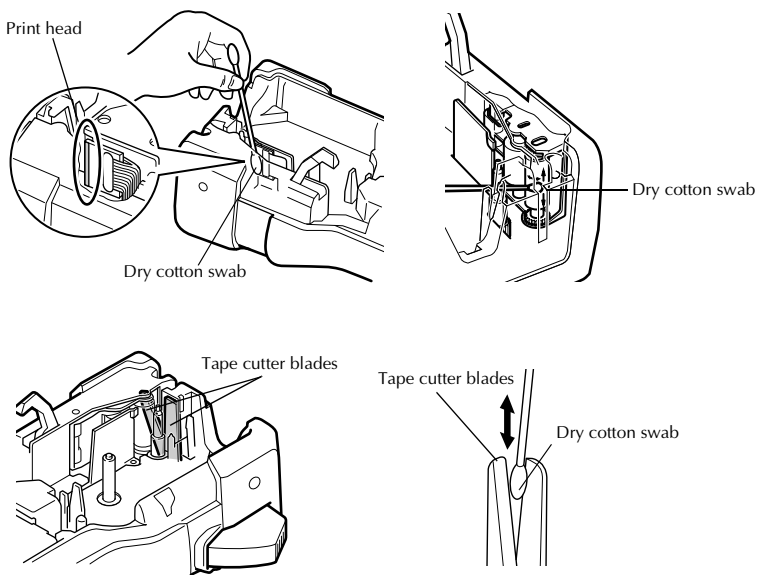



## Notes on cleaning the print head & rollers

---

- ☞ If a blank horizontal streak appears through the label text, clean the machine's print head.
- ☞ The print head can be cleaned more easily if the optional print head cleaning cassette (TZ-CL4) is used.

## Notes on cleaning the tape cutter

---

- ☞ If the tape cannot be cut correctly, clean the tape cutter blades.

## 5 *Using P-touch Labeller With a Computer*

This P-touch labeller is equipped with a USB port, allowing you to connect it to a computer running Microsoft® Windows®. You will need to install the printer driver to use your printer with your computer. You will also need to install P-touch Editor label design software. The enclosed CD-ROM contains P-touch Editor 5.0, which is installed together with the printer driver and P-touch Transfer Manager.

- **P-touch Editor 5.0** is a label-designing software that provides additional illustration and layout features enabling you to design more elaborate label templates and create databases. Once these label templates and databases have been created, they can be downloaded to the P-touch labeller, where they can be used to print labels.

- ☞ **The P-touch Editor software and the printer driver must be installed before the P-touch labeller is connected to the computer or turned on.**
- ☞ Only use the enclosed USB interface cable to connect the P-touch labeller to the computer.
- ☞ Only one P-touch labeller model PT-7600 can be connected to a computer at a time.
- ☞ **Although the P-touch labeller can be connected to the computer through a USB connection, label layouts created in P-touch Editor cannot be printed directly from the application.**
- ☞ If you encounter installation problems, try connecting the USB interface cable directly to your computer USB port (and not to a USB hub), or try a different USB port on your computer.

## CD-ROM Precautions

- Do not scratch the CD-ROM.
- Do not subject the CD-ROM to extremely high or extremely low temperatures.
- Do not put heavy objects on the CD-ROM or apply force to the CD-ROM.
- The software contained on the CD-ROM is meant for use with your purchased machine only.

It may be installed on multiple PCs for use at an office, etc.

---

## System requirements

---

Before installation, check that your system configuration meets the following requirements.

<b>Operating system</b>	Microsoft® Windows® XP / Windows Vista® / Windows® 7
<b>Memory</b>	Windows® XP: More than 128 MB Windows Vista®: More than 512 MB Windows® 7: More than 1 GB (32-bit) or 2 GB (64-bit)
<b>Hard disk free space</b>	70MB or more
<b>Interface</b>	USB Port (USB Specification 1.1 or 2.0 protocol)
<b>Monitor</b>	SVGA High Color graphics support or higher
<b>Other</b>	CD-ROM drive for installation

---

## Installing the P-touch Editor 5.0 and Printer driver

---

 Do not connect the USB cable to your PC before installing the software.

## Installing the P-touch Editor 5.0

☞ The installation procedure may change depending on the Operating System on your PC. Windows Vista® is shown here as an example.

- 1 Start your PC making sure to log on as a user with Administrator privileges.
- 2 Insert the CD-ROM into the CD-ROM drive. The P-touch Setup Screen will appear.

☞ If the P-touch Setup Screen does not appear, from Windows Explorer double-click the My Computer icon, and then double-click the PT-7600 icon. If you wish to cancel installation in the middle of the process, click [Exit].

- 3 Select the desired language, and double click the type of setup you prefer.  
**Standard:** All features (P-touch Editor and Printer driver) will be installed (default).  
**Custom:** You can specify which features to install. Recommended for advanced users.



- 4 Read the license agreement carefully. If you agree with the terms and conditions of the license agreement, click [Yes] to continue the installation.
- 5 Type in the User Name and Company Name (if needed), and then click [Next].
- 6 Confirm the destination to install the software, and then click [Next].

☞ If you wish to modify or change the destination, click [Browse] to choose the installation path.

- 7 Check on/off which shortcuts you wish to add, and then click [Next].
- 8 Review the settings, and then click [Next]. (To change the settings, click [Back] to go back to the appropriate window(s) and correct.)
- 9 The selected features will be installed automatically.

## Installing the Printer driver

- Read the contents of the “Before installing the printer driver” dialog box, and then check [Yes, confirmed] and click [OK].



The installation procedure for the printer driver differs depending on the operating system being used.

- For Windows® XP (page 49)
- For Windows Vista® / Windows® 7 (page 50)

### For Windows® XP

- Although a message warning that no digital signature was found appears soon after driver installation begins, click [Continue Anyway].



- When prompted, connect your P-touch labeller to the PC by using a USB cable, and then hold down  and press  to turn on the P-touch labeller in Transfer mode.

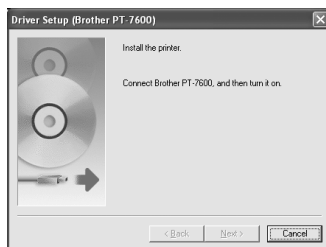
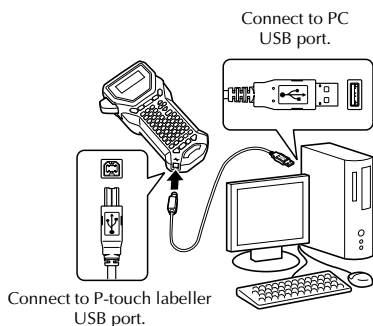

- The printer is detected, and then the “Found New Hardware Wizard” starts up. Select [No, not this time], and then click [Next]. In the dialog box for selecting the installation method, select “Install the software automatically (Recommended)”, and then click [Next].

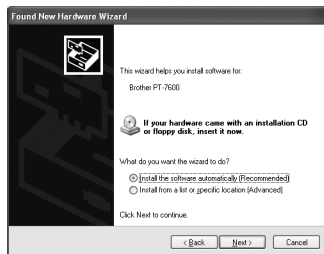



- Again, a message appears warning that no digital signature was found. Click [Continue Anyway] to install the printer driver. When a message appears, indicating that the printer has been added, click [OK] to close the message.



- You will be prompted to register your P-touch labeller online, click [Yes] and then click [Next]. If you have selected to register the product your default internet browser will be launched in a new window.
- Click [Finish] to complete the installation. Restart your PC if you are instructed to do so.

## For Windows Vista® / Windows® 7

- When the message confirming installation of software published by Brother appears, click [Install].
- When prompted, connect your P-touch labeller to the PC by using a USB cable, and then hold down  and press  to turn on the P-touch labeller in Transfer mode.

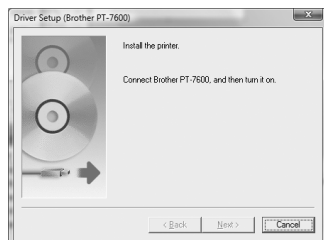
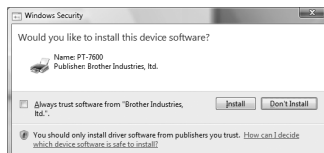

- 3 The printer is detected, and then the driver is installed.
- 4 You will be prompted to register your P-touch labeller online, click [Yes] and then click [Next]. If you have selected to register the product your default internet browser will be launched in a new window.
- 5 Click [Finish] to complete the installation. Restart your PC if you are instructed to do so.

---

## Uninstalling the P-touch Editor 5.0

---

The uninstall procedure for the P-touch Editor 5.0 differs depending on the operating system being used.

---

### Uninstalling P-touch Editor

---

#### 1 For Windows® XP

From the "Control Panel", go to "Add or Remove Programs".  
The "Add or Remove Programs" window appears.

#### For Windows Vista® / Windows® 7

From the "Control Panel", go to "Programs" and open "Programs and Features".  
The "Uninstall or change a program" window appears.

#### 2 For Windows® XP

Choose "Brother P-touch Editor 5.0", and click [Remove].

#### For Windows Vista® / Windows® 7

Choose "Brother P-touch Editor 5.0", and click [Uninstall].  
When the "User Account Control" dialog box appears, click [Continue]. If a password is requested, type in the password, and then click [OK].

#### 3 Click [OK].

The uninstall operation starts. After the software is removed from your computer, the "Maintenance Complete" dialog box appears. Click [Finish].

#### 4 Close the "Add or Remove Programs (XP) / Programs and Features (Windows Vista® / Windows® 7)" window.

The P-touch Editor has been uninstalled.

---

## Uninstalling / Replacing the printer driver

---

In the following steps, you will see PT-XXXX. Read "XXXX" as your printer name.

### Uninstalling the printer driver

---

**1** Turn off the printer.

**2 For Windows® XP**

Click the "Start" button, go to "Printers and Faxes" window.

**For Windows Vista®**

From the "Control Panel", go to "Hardware and Sound" and open "Printers".

**For Windows® 7**

Click "  ", go to [Devices and Printers].

 For details, see Windows® Help.

**3 For Windows® XP**

Choose "Brother PT-XXXX", and click "File"->"Delete" or right click on the icon and then click [Delete].

**For Windows Vista® / Windows® 7**

Choose "Brother PT-XXXX", or right click on the icon and then click [Delete] (Windows Vista®) / [Remove device] (Windows® 7).

**4 For Windows® XP**

Go to "File"->"Server Properties".

The "Print Server Properties" window appears.

**For Windows Vista®**

In the "Printers" window, right click and select "Run as administrator"->"Server Properties...".

If the authorization confirmation dialog appears, click [Continue].

If the "User Account Control" dialog appears, enter the password and click [OK].

The "Print Server Properties" window appears.

**For Windows® 7**

Choose "Fax" or "Microsoft XPS Document Writer" in the "Devices and Printers" window, and then click "Print server properties", which appears in the menu bar.

The "Print Server Properties" window appears.



### 5 For Windows® XP

Click the "Drivers" tab and choose "Brother PT-XXXX". Then, click [Remove]. Go to step 7.

### For Windows Vista®

Click the "Drivers" tab and choose "Brother PT-XXXX". Then, click [Remove...].

### For Windows® 7

Click the "Drivers" tab, and then click "Change Driver Settings".

If a User Account Control message appears, type in the password, and then click [OK].

Choose "Brother PT-XXXX", and then click [Remove...].

### 6 For Windows Vista® / Windows® 7

Choose "Remove driver and driver package" and click [OK].

### 7 Close the "Print Server Properties" window.

The printer driver has been uninstalled.

## Using P-touch Editor 5.0

P-touch Editor 5.0 makes it easy for anyone to design and print more complex labels, for almost any needed imaginable.

See the P-touch Editor Help for samples of various kinds of labels and details on creating, printing, and saving the labels. The following is the example for Windows Vista®.

### Notes on creating templates

Since some P-touch Editor 5.0 functions are not available with the P-touch labeller machine, keep the following points in mind when using P-touch Editor 5.0 to create templates.

- ☞ Since only the Helsinki font is available on the P-touch labeller machine, the font used to print the text may be different from the font selected for the template in P-touch Editor. In addition, since the size of all text on the P-touch labeller machine is set to **AUTO**, the text size may automatically be reduced. We recommend using the Helsinki font installed with P-touch Editor for best results when creating labels.
- ☞ Although character styles can be applied to individual characters with P-touch Editor, styles can only be applied to a line of text with the P-touch labeller machine. In addition, some character styles are not available on the P-touch labeller machine.
- ☞ Unlike from P-touch Editor, the P-touch labeller machine cannot print underline or strikeout characters.

- ☛ Only the first 999 rows of a database linked to a template are read by the P-touch labeller machine.
- ☛ Only the first line of text typed into a database field is read by the P-touch labeller machine. Therefore, if you wish to print from a database with more than one line of text, create the template and database with separate fields for each line of text.
- ☛ Some characters available with P-touch Editor are not available with the P-touch labeller machine.
- ☛ Bar codes specified with settings not compatible with the P-touch labeller bar codes settings will not print correctly.
- ☛ A template created with P-touch Editor should have a fixed length with a maximum of 40" (1 m).
- ☛ The template and database should be created so that no more than approximately 500 characters per label will be printed.
- ☛ Fields that extend out of the print area may not print completely.
- ☛ A numbering field specified with P-touch Editor will not transfer and is not compatible with the **Numbering** function on the P-touch labeller machine.
- ☛ Backgrounds specified with P-touch Editor are not compatible with the P-touch labeller machine.
- ☛ Time and date objects using the "At Printing" setting on P-touch Editor will not be printed.
- ☛ The printed label may differ from the image that appears in the Preview area of Transfer Manager.
- ☛ If the number or order of fields in a database are changed and only the database (\*.csv file) is transferred to update it, the database may not link correctly with the template. In addition, the first line of data in the transferred file must be recognized by the P-touch labeller machine as "field names", otherwise the database cannot be used to print.
- ☛ A P-touch Editor layout that uses the split printing function (enlarging the label and printing it on 2 or more labels) cannot be transferred.
- ☛ The label length settings in P-touch Editor and the P-touch labeller machine, may differ slightly due to minor variations in mechanical operation.
- ☛ When mixing bitmap objects (TIFF, JPEG, BMP) with vector objects (other than TrueType fonts), everything is combined into a single bitmap at the printer resolution (180 dpi) and only the TrueType font data can be edited from the PT-7600 keyboard.
- ☛ Grouped objects, including TrueType font data will be converted into a single bitmap from which the data can not be edited from the PT-7600 keyboard.
- ☛ Downloading logos, symbols and graphics into the PT-7600 PF key will automatically be scaled (to 8 sizes) like the resident font or any of the resident symbol in the library.

## Starting P-touch Editor

- 1 Click [Start]-[All Programs (Programs)]-[Brother P-touch]-[P-touch Editor 5.0].

☞ You can also start P-touch Editor using the following methods (only if you created the shortcut during installation):

- Double-click the shortcut icon on the desktop.
- Click the shortcut icon in the Quick Launch bar.

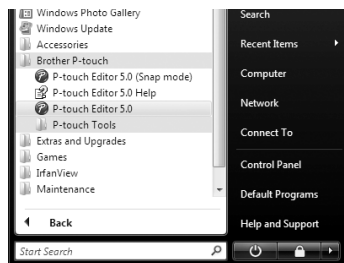

When P-touch Editor is launched, the [New/Open] dialog box appears, allowing you to choose whether you want to create a new label layout or open an existing label.

☞ To specify how the P-touch Editor works when it starts, click [Tools]-[Options] to display the [Options] dialog box. In the [General] tab, you can choose the setting in the [Operations] list box in the [Startup Settings]. Normally, choose [Display New/Open Dialog Box].

- 2 Choose an option in the [New/Open] dialog box and click [OK].

- You can choose the label printer and tape size.
- When you choose [Open File], the [Open] dialog box appears. You can choose and open the file you have created and stored previously.
- When you choose [View History], the [History] dialog appears. You can choose from recently created labels.
- When you choose [New], choose either vertical writing style or horizontal writing style.
- When you choose [Select by Use], you can choose by label applications.
- When you click [Help-How To], the P-touch Editor Help appears. The Help files allow you to learn step by step how to create a label layout.
- When you choose [Check for Updates] with a computer connected to the Internet, you will be taken to the Brother Solutions Center (<http://solutions.brother.com>). Use the Brother Solutions Center to check for the latest software downloads and FAQs.

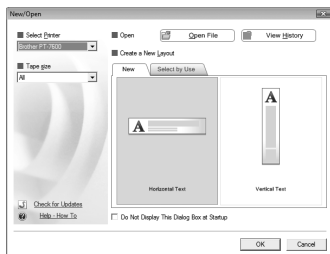

# Layout window

## Express Mode

This mode provides easy label creation with text and images.

The layout window consists of the following sections:

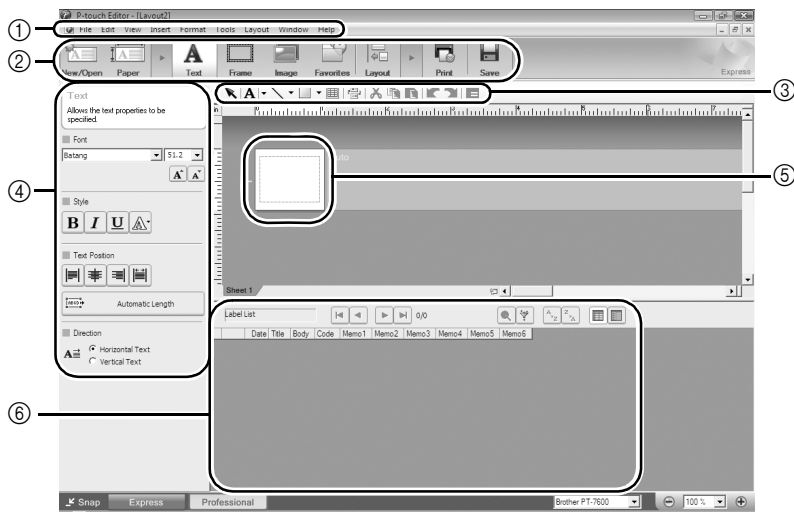

### ① Menu bar

Commands are categorized under each menu (File, Edit, View, and Insert, etc.) by function.

### ② Command bar

The command bar contains the New/Open, Paper, Text, Frame, Image, etc.

### ③ Draw/Edit toolbar

Provides tools for choosing an object, entering text, drawing graphics, etc.

### ④ Property bar

You can easily insert and format text, images, etc.

### ⑤ Layout window

The layout window is used to display and edit objects.

### ⑥ Database window

Displays a connected database.

- ☞ The [View] menu allows you to show/hide the toolbars and windows.
- ☞ See the P-touch Editor Help for details.

## Professional Mode

This mode provides full-scale label creation for creating the templates.  
The layout window consists of the following sections:

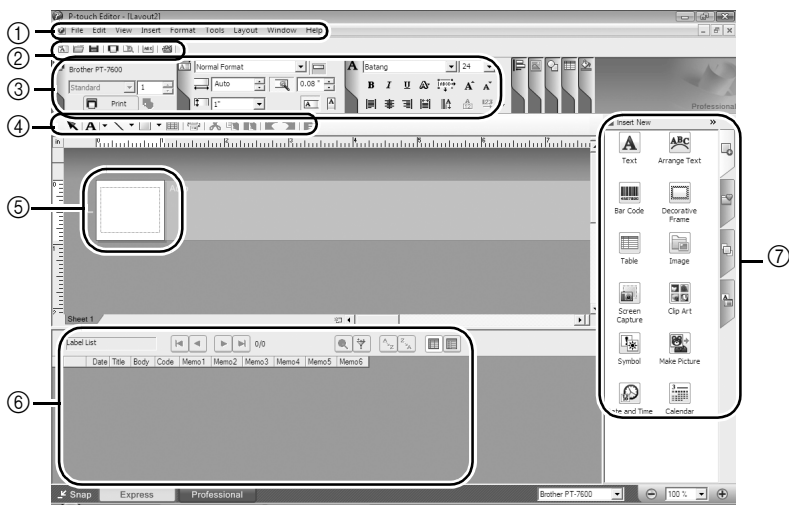

### ① Menu bar

Commands are categorized under each menu (File, Edit, View, and Insert, etc.) by function.

### ② Standard toolbar

A group of frequently used commands (New Layout, Open, Save, Print, etc.) are provided in this toolbar.

### ③ Property palette

The property palette contains the Print, Paper, Text, and Layout property boxes. Click on the left side of each palette to show/hide the box.

### ④ Draw/Edit toolbar

Provides tools for choosing an object, entering text, drawing graphics, etc.

### ⑤ Layout window

The layout window is used to display and edit objects.

### ⑥ Database window

Displays a connected database.

### ⑦ Side bar

By selecting the tab, you can easily insert and format text, bar codes, frames, tables, figures and arrange objects.

- ☞ The [View] menu allows you to show/hide the toolbars, palettes, and windows.
- ☞ See the P-touch Editor Help for details.

## Snap Mode

With this mode, you can capture the screen, print it as image, and save it for future use. To start Snap Mode, follow the steps below.

- 1 When you click [Snap Mode], the Snap Mode description dialog box appears. Click [OK].

- ☞ If you put a checkmark in [Do Not Display This Dialog Again], you can go to Snap Mode directly from next time.
- ☞ You can also start from [Start]-[All Programs (Programs)]-[Brother P-touch]-[P-touch Editor 5.0 (Snap mode)].

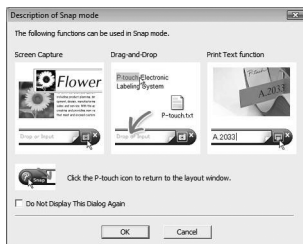

- 2 Snap Mode appears.

- ☞ See the P-touch Editor Help for details.



## Starting P-touch Editor Help

This section explains how to start P-touch Editor Help for Windows. The following is the example for Windows Vista®.

### Starting from Start button

- 1 Click [Start]-[All Programs (or Programs)]-[Brother P-touch]-[P-touch Editor 5.0].

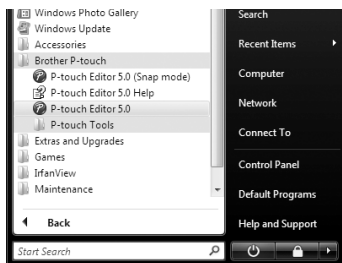

- 2 In the [New/Open] dialog, click [Help-How To].

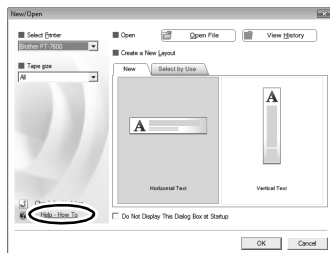

## Starting from P-touch Editor

Click Help menu and choose P-touch Editor Help.

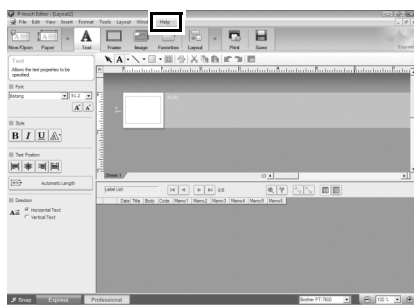

Express Mode

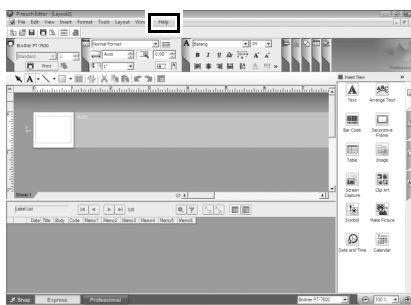

Professional Mode

## Starting from Snap Mode

Right click the mouse and choose P-touch Editor Help.

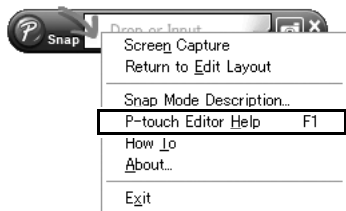

## Printing the Help description

The information given in P-touch Editor Help can be printed. Use your normal printer to print the P-touch Editor Help information.

- 1 In the [Contents] tab, choose any topic you want to print.
- 2 Click  on the Toolbar.
- 3 Choose the range of topics to be printed, and click [OK].

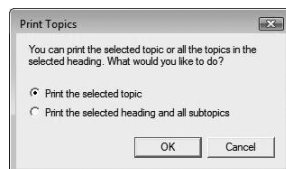



- 4 Specify the [Printer] and click [Print].

☞ Choose a normal printer that supports general paper sizes, such as A4 or Letter.

## Transferring Data To/From a Computer

A template, database or a user-defined character image (character not available on the P-touch labeller) can be transferred from the computer and assigned to a PF key on the P-touch labeller.

### Entering Transfer mode

- Hold down  and press  to turn on the P-touch labeller in Transfer mode.

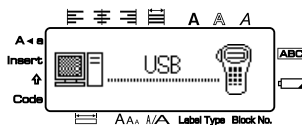

- ☞ To exit Transfer mode, press  to turn off the P-touch labeller.
- ☞ **Be sure not to turn off the P-touch labeller while data is being sent to it, otherwise the data will be lost.**
- ☞ Regardless of whether the P-touch labeller is being operated from battery or the AC adapter, the machine will automatically turn off if no key is pressed or no operation is performed for 5 minutes.
- ☞ If you have software problems with transferring data to or from the P-touch labeller, try resetting the P-touch labeller as described on page 73.



## How to use P-touch Transfer Manager & P-touch Library

⚠ Although the PT-7600 can be connected to the computer through a USB connection, label layouts created in P-touch Editor cannot be printed directly from the application.

**P-touch Transfer Manager:** The PT-7600 can transfer templates created in P-touch Editor. Also, you can save the Label templates data from P-touch labeller onto the computer as a back up.

**P-touch Library:** This application allows you to manage P-touch labeller label templates and other data on the computer.

---

### Starting up P-touch Transfer Manager

---

- 1 Click the [Start] button, then choose [All programs (Programs)] - [Brother P-touch] - [P-touch Tools] - [P-touch Transfer Manager 2.1].  
P-touch Transfer Manager starts up.

## Layout window

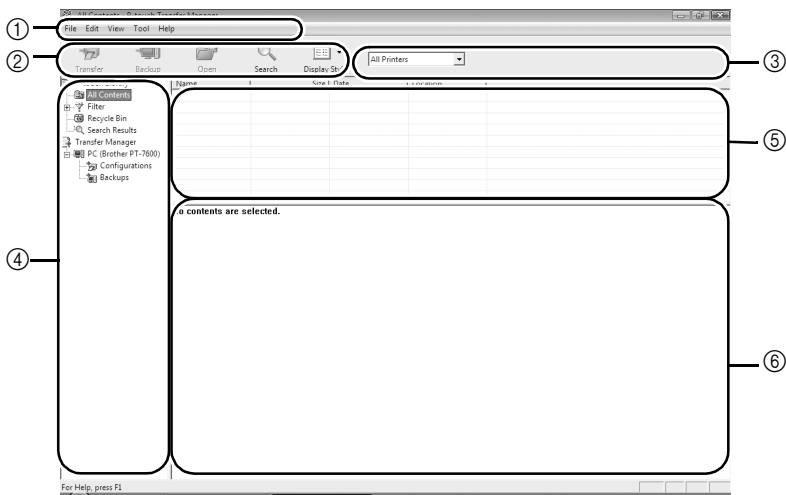

### ① Menu

Commands are categorized into each menu (File, Edit, View, Tool, and Help) by function.

### ② Toolbar

There are icons for frequently used commands. Click on one to access that command.

### ③ Selecting the printer model (Only for P-touch Transfer Manager)

Select the printer model to send data to. When you select a printer, only the data that can be sent to the selected printer is displayed in the list view.

### ④ Folder view

Displays a list of folders. When you select any folder, the data in the folder selected is displayed in the list view on the right.





### ⑤ List view

The data in the selected folder is displayed.

### ⑥ Preview

The label templates selected in the list view are displayed as a preview.

## Explanations of the Icons

Icon	Button name	Function
	Transfer (Only for P-touch Transfer Manager)	Transfers the label templates and other data on your PC to the P-touch labeller (when connecting USB interface cable).
	Backup (Only for P-touch Transfer Manager)	Backs up the data you have transferred to the P-touch labeller using the P-touch Transfer Manager.
	Open	Edits the selected data.
	Search	Searches the data managed with the P-touch Library.
	Display Style	Changes the file display format.

## Transferring label templates from the PC

- 1 Select the P-touch labeller to transfer data to.

 Make sure that the P-touch labeller is in Transfer mode. (For more details, refer to *Entering Transfer mode* on page 60.)

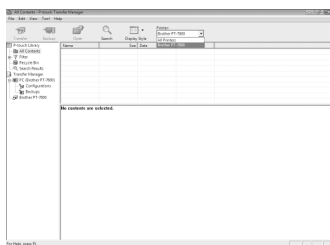

- 2 Right click the [Configurations] folder, then select [New] and create a new folder. Here, as an example, we create the folder "Transfer".

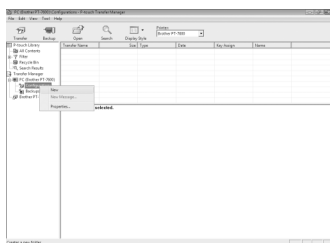

- 3 Drag the transfer data to the folder you created.  
Drag the transfer data from All contents, Layouts or another folder under Filter.  
When transferring multiple sets of data, you can move all the transfer data to the folder you created.

- 4 Key Assign numbers are automatically assigned to transferred data inside the folder you made in the previous step.  
To change a number, right click the data name in the list view, then select the Key Assign number.

- Key Assign is necessary for transfer of data other than message texts.
- If you change the Key Assign number used for data which has already been transferred to the P-touch labeller, the data will be overwritten. You can check the Key Assign number used for data already transferred to the P-touch labeller by backing up the data as explained in *Backing up label templates* on page 69.
- You can click the data name for transfer data and change to a new name. The character limit is 15 words.

- 5 Select the data or folder you want to transfer, then click  .  
The transfer confirmation message is displayed.

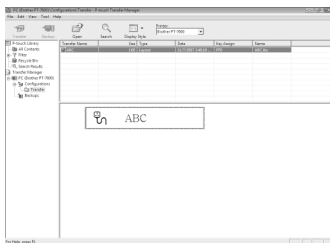
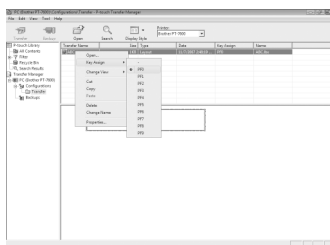
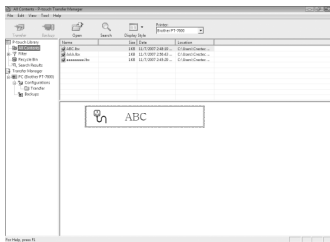

- 6 Click [OK].  
The data in the folder selected in the folder view is transferred to the P-touch labeller.

If you have selected specific data in the list view, only that selected data is transferred to the P-touch labeller.

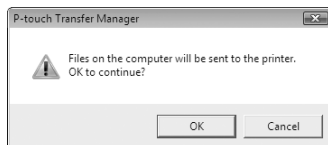

## Adding a user-defined character image to the text

If a user-defined character image (a bitmap character not usually available on the P-touch labeller) is assigned to a PF key, that character can be added to any label that you create on the P-touch labeller.

- Press , then the applicable PF key.  
The character is added to the text at the cursor's position.

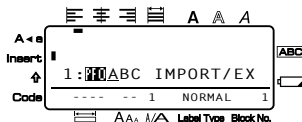

- Only a monochrome bitmap (\*.bmp) file can be transferred to the P-touch labeller.
- The downloaded image is automatically resized to the width of the tape being used. The maximum graphics size is 2048 x 2048 dot.

## Using template data

A label layout created with P-touch Editor (\*.lhx file) can be transferred to the P-touch labeller, where it can be used as a template for printing labels. Templates can be printed using text from either a database, or by directly typing text in.

When a database (Excel file, Access file, \*.mdb file created with P-touch Editor 5.0 or \*.csv file) is transferred to the P-touch labeller, data from the selected records can be added to multiple linked templates also transferred to the P-touch labeller, or to any new label created from the P-touch labeller keyboard. In addition, you can use the P-touch labeller keyboard to search the database to find specific records.

- The P-touch labeller can only contain one database at a time. However, the database can be replaced or updated.



## Using a template not linked to a database

Using a template not linked to a database is the same as using any of the preset Auto Format templates. For details on using Auto Format templates, refer to *Using the pre-formatted Auto Format templates* on page 32.





 P-touch Editor 5.0 will convert grouped text objects into a graphic image and can not be edited when transferred to the P-touch labeller.

## Using a template linked to a database

A single record or a range of records in the database linked to the template can be printed.

- 1 Press , then the PF key where the template that you wish to use is assigned.
- 2 Press . The database data is displayed.





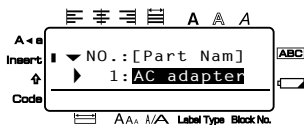







**To select a single database record to be printed in the template:**









- 3 Press  or  to highlight the desired record, and then press .
- 4 To edit any text in the record, press  or  to display the text, and then type in the new text.



- 5 Press .

**To select a range of database records to be printed in the template:**







- 3 Press  or  to highlight a record, and then press .
- 4 Press , then . The message "CLEAR TEXT & PRINT DATABASE?" appears.
- 5 Press .
- 6 Press  or  until **RECORD NO.** is displayed, and then specify the desired range of records.
- 7 Press  (or ). **START** appears in the Print Option menu.
- 8 Press  (or ) to begin printing the labels using the specified range of records.

- ☞ If the Cut function is set to **1** or **3**, the message “CUT TAPE TO CONTINUE” appears after each label is printed. Press the tape cutter button to cut off the label and continue printing.
- ☞ Be sure to cut the tape within 5 minutes from the time that the message appears.
- ☞ For the different options available for cutting the tape, refer to *Selecting how tape is fed and cut* on page 41.
- ☞ To search for a specific record while the database data is displayed (in step **2** above), refer to *Searching the database* on page 69.
- ☞ To view other fields in the record selected in step **3**, press  or .
- ☞ When editing data as described in step **4** of the procedure for printing a single database record, the database remains unchanged. When printing a range of database records, the text cannot be edited.
- ☞ To specify settings for additional Print Option functions, instead of continuing with step **8**, press  or  until **CONTINUE** is displayed in the Print Option menu, and then press . (Refer to *Printing multiple copies of a label* on page 34 and *Printing mirrored labels* on page 37.)
- ☞ To quit using the template, display the last field, and then press . The template menu appears. Press  or  until **EXIT** appears, and then press .
- ☞ While trying to print a large amount of data at one time, some outputted labels may be blank. For example, when printing 50 records, the maximum number of characters that can be printed at one time is limited to approximately 200.

## Using downloaded database data

An Excel, Access, \*.mdb database created with P-touch Editor 5.0, or a database converted to a \*.csv file can be transferred to the P-touch labeller. The database data can be used either with a linked template transferred to the P-touch labeller, or added to a label created from the P-touch labeller keyboard.













### Adding database data to a label



- 1** Move the cursor to place in the text where you wish to add the database data.
- 2** Press , then .
- 3** Press  or  until the record containing the desired data is flashing.
- 4** Press  or  until the desired data is flashing.
- 5** Press . The selected data is added to the label text.



To search for a specific record, refer to *Searching the database* on page 69.

## Using database data in a Label Type mode

This function enables you to select the range of database fields to print.

- 1 Press , and then select the Label Type mode as described in chapter 2.
- 2 Press , then . The message “CLEAR TEXT & PRINT DATABASE?” appears.
- 3 Press .
- 4 Press  or  until **RECORD NO.** is displayed, and then specify the desired range of records.
- 5 Press  or  until **FIELD NO.** is displayed, and then specify the desired range of record fields.
- 6 Press  (or ). **START** appears in the Print Option menu.
- 7 Press  (or ) to begin printing the labels using the specified range of records.

If label text has been typed in, you will be asked to choose either **TEXT PRINT** or **DATA PRINT** when , then  is pressed. At this time, select **DATA PRINT**. If **TEXT PRINT** is selected, the special printing functions for printing multiple copies of labels (refer to page 34), printing multiple copies with incremental characters (refer to page 35), printing a range of text blocks (refer to page 36), or printing the label text as a mirror image (refer to page 37) are available.

To specify settings for additional Print Option functions, instead of continuing with step 7, press  or  until **CONTINUE** is displayed in the Print Option menu, and then press . (Refer to *Printing multiple copies of a label* on page 34 and *Printing mirrored labels* on page 37.)

While trying to print a large amount of data at one time, some outputted labels may be blank. For example, when printing 50 records, the maximum number of characters that can be printed at one time is limited to approximately 200.



## Searching the database

While selecting a database record to be used in a template or while selecting a database record whose data is to be added to a label, the database can be searched for records containing specific characters or records with a specific number.

### To search the database for a record containing specific characters:

- 1 Press and until the search screen is displayed.
- 2 Type in the characters that you wish to search for.
- 3 Press . The first record after the currently selected one that contains the entered characters appears.

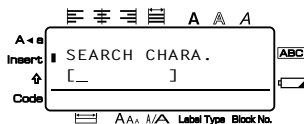

### To display a record with a specific number:

- 1 When the search screen is displayed, presses and until the jump screen is displayed.
- 2 Press or until the desired record number is displayed, or use the number keys to type in the desired number.
- 3 Press . The record with the specified record number appears.

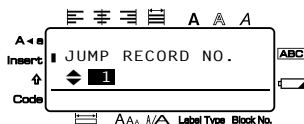

## Backing up label templates

This transfers label templates and other data in the P-touch labeller to the PC.

- ☞ Valid only when connecting USB cable.
- ☞ Backed up data cannot be edited on the PC.
- ☞ It may not be possible to transfer backed-up data to printers of a different specification from one which the data was originally backed up from.

- 1 Connect the P-touch labeller to the PC with the USB cable, and hold down and press to turn on the P-touch labeller in Transfer mode. The P-touch labeller model name is displayed in the folder view. If you select a P-touch labeller model in the folder view, the current data transferred to the PC is displayed.

- 2 Select the P-touch labeller to back up from, then click  .  
The backup confirmation message is displayed.

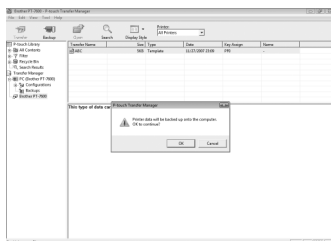

- 3 Click [OK].  
A new folder with a name containing the current date is created inside the P-touch labeller folder, and all the P-touch labeller's data is transferred to that new folder.

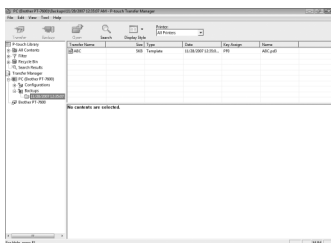

## Deleting all the P-touch labeller data

- 1 Connect the PC and the P-touch labeller by cable and turn on the machine's power.  
The P-touch labeller model name is displayed in the folder view.
- 2 Right click the P-touch labeller, then select [All Delete].  
The confirmation message is displayed.

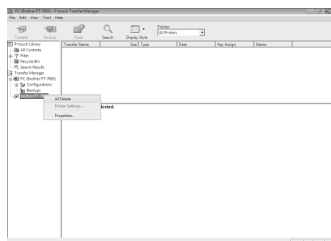

- 3 Click [OK].  
All P-touch labeller data is erased.

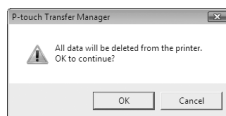

## Starting up the P-touch Library

You can use the P-touch Library to access labels you wish to edit.

- 1 Click the [Start] button, then choose [All programs (Programs)] - [Brother P-touch] - [P-touch Tools] - [P-touch Library 2.1].  
The P-touch Library starts up.

## Opening and editing data

- 1 Choose the data you want to edit, then click



The application associated with the data is opened and you can edit the data.

 The application that starts up depends on the data. For example, for a P-touch labeller template, P-touch Editor starts up.

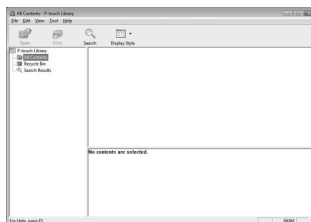

## Searching labels

You can search label templates registered in the P-touch Library.

- 1 Click  .  
The [Search] dialog box is displayed.

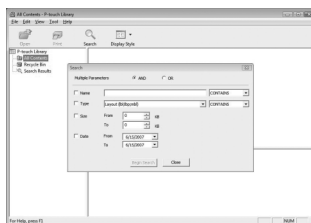

- 2 Check the items to be used as search conditions and set the search items.  
The search items that can be set are as follows.

Settings	Details
Multiple Parameters	This sets the method for combining multiple search items. If you choose AND, files are searched for those that satisfy all the conditions. If you choose OR, files are searched for those that satisfy any one of the conditions.
Name	Inputs the data name to search for.
Type	Chooses the data type to search for.
Size	Sets the data size to search for.
Date	Sets the date and time at which the data to search for was last modified.



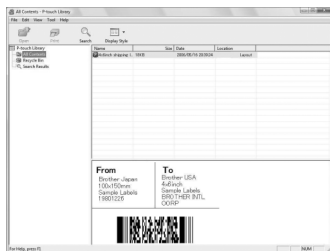

- 3 Click [Begin Search].  
The search is started and the search results are displayed.



- ☞ The search results can be checked in the Search Results folder view.
- ☞ You can register the data in the P-touch Library by dragging and dropping to the All contents folder or its list view. To have label templates created with P-touch Editor automatically registered in the P-touch Library, use the following method.
  1. From the P-touch Editor menu, choose [Tools] - [Options].
  2. In the [Options] dialog box [General] tab, click [Registration Settings].
  3. Choose the timing for registering label templates created with P-touch Editor, then click [OK].

## Resetting the P-touch Labeller

You can reset the internal memory of your P-touch labeller when you want to clear all saved label files, or in the event the P-touch labeller is not working properly.

- 1 Turn off the machine and then while holding down  and , press  to turn the machine back on.
- 2 Release  and .  
The P-touch labeller turns on with the internal memory reset.

- ⓘ Release  before releasing the other keys.
- ⓘ All text, format settings, option settings and stored label files (except for the Auto Format templates), are cleared when you reset the P-touch labeller. Language and unit settings will also be cleared.



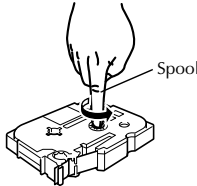

## Troubleshooting



Problem	Cause	Solution
The screen 'locks', or the P-touch labeller does not respond properly.		Refer to <i>Resetting the P-touch Labeller</i> above and reset the internal memory to the initial settings. If resetting the P-touch labeller does not solve the problem, disconnect the AC adapter and remove the battery for more than 10 minutes.
The display remains blank after turning on the power.	Is the AC adapter connected correctly?	Check that the AC adapter designed exclusively for your P-touch labeller is connected correctly.
	Are you using the correct AC adapter?	Make sure that you are using the AD-18 designed exclusively for your P-touch labeller (included in package).
	Is the battery installed correctly?	Remove and re-install the battery.
	Is the rechargeable battery pack charged sufficiently?	The rechargeable battery pack's charge may be low. Charge the rechargeable battery pack. (The rechargeable battery pack's charge may run low even when you are not using the P-touch labeller.)

Problem	Cause	Solution
<b>The label is not printed after pressing</b> 	Has text been entered?	A label will not print if there is no text entered.
	Is the tape cassette installed correctly, and is there enough tape remaining?	Check that the tape cassette is installed correctly, and that there is enough tape remaining.
	Is the end of the tape bent?	If bent, cut the bent section of tape with scissors and thread the tape through the tape exit slot correctly.
	Is the tape jammed?	If jammed, remove the tape cassette, carefully pull out the jammed tape, and then cut the tape with scissors. Check that the end of the tape passes through the tape guide, and reinstall the tape cassette.
	Is the tape compartment cover open?	If so, close the tape compartment cover correctly.
<b>The LCD messages are displayed in a foreign language.</b>	Is the language set properly?	Refer to <i>Changing the Language</i> on page 11 and select the desired language for the LCD messages.
<b>The label is not printed correctly.</b>	Is the tape cassette installed correctly?	When installing a cassette, press firmly until it clicks into place.
	Is the print head clean?	If not, clean the print head using a cotton swab or optional print head cleaning cassette (TZ-CL4).
	Is the rechargeable battery pack charged sufficiently?	If the battery indicator comes on, charge the rechargeable battery pack.
<b>The ink ribbon is separated from the ink roller.</b>	Is the ink ribbon in the tape cassette loose, or did you pull on the label coming out of the tape exit slot?	<p>If the ink ribbon is broken, replace the tape cassette. If not, leave the tape uncut and remove the tape cassette, then wind the loose ink ribbon onto the spool as shown in the figure.</p> 
<b>The P-touch labeller stops while printing a label.</b>	Is there enough tape remaining in the tape cassette?	The striped tape indicates you have reached the end of the tape. Replace the tape cassette when the striped tape appears.
	Are the batteries weak and is the AC adapter disconnected?	Replace all batteries or connect the AC adapter directly to the P-touch labeller.



Problem	Cause	Solution
Label files saved previously are now empty.	Have the batteries and AC adapter been disconnected?	All files stored in the internal memory are lost if the batteries and AC adapter are disconnected for longer than two minutes.
	Is there enough power remaining in the batteries?	All data stored in the internal memory is lost if the batteries become empty or the AC adapter is disconnected.
	Have you used the Reset function?	The resetting function clears all data stored in the internal memory, including label files.



## Error Message List



Error Message	Cause	Solution
<b>1 BLOCK LIMIT!</b>	<ul style="list-style-type: none"> <li>This message appears if you try to use the Numbering function when multiple blocks of text have been entered with the <b>PANEL1</b> Label Type mode selected.</li> </ul>	<ul style="list-style-type: none"> <li>Cancel the Numbering function.</li> <li>Limit the number of text blocks to 1.</li> </ul>
<b>7 LINE LIMIT!</b>	<ul style="list-style-type: none"> <li>This message appears if 7 lines have already been entered in a text block when you press .</li> </ul>	<ul style="list-style-type: none"> <li>Limit the number of lines in a text block to 7.</li> <li>Adjust the number of lines so that the block will not have more than 7 lines.</li> </ul>
	<ul style="list-style-type: none"> <li>This message appears if you delete , causing the number of lines in a block to exceed the 7-line limit.</li> </ul>	
<b>50 LINE LIMIT REACHED!</b>	<ul style="list-style-type: none"> <li>This message appears if 50 lines have already been entered when you press , then .</li> </ul>	<ul style="list-style-type: none"> <li>Limit the number of lines to 50.</li> </ul>
<b>BAR CODE TOO LONG!</b>	<ul style="list-style-type: none"> <li>The message appears if the length of the bar code is longer than 8.8" (22 cm) when pressing .</li> </ul>	<ul style="list-style-type: none"> <li>Reduce the width of the bar code.</li> </ul>

Error Message	Cause	Solution
<b>BLOCK NO. CHANGE CLEAR TEXT?</b>	<ul style="list-style-type: none"> <li>The message appears when changing from a different Label Type mode to the PANEL2 Label Type mode and the current block number is different from the previously used block number.</li> </ul>	<ul style="list-style-type: none"> <li>Press  to use the PANEL2 Label Type mode. All text is cleared.</li> <li>Press  to select a different Label Type mode.</li> </ul>
<b>BUFFER EMPTY!</b>	<ul style="list-style-type: none"> <li>This message appears if no text has been typed in when you try to print or Preview function.</li> </ul>	<ul style="list-style-type: none"> <li>Type in some text before trying to perform any of these operations.</li> </ul>
<b>BUFFER FULL!</b>	<ul style="list-style-type: none"> <li>This message appears if you try to add a character, a space, a new line, a new block, a symbol, an accented character or a bar code after the maximum number of characters has already been entered.</li> </ul>	<ul style="list-style-type: none"> <li>Delete some existing text before trying to add any more.</li> </ul>
<b>CHECK # OF DIGITS ENTERED!</b>	<ul style="list-style-type: none"> <li>This message appears if less than the minimum one digit are entered as the bar code data.</li> </ul>	<ul style="list-style-type: none"> <li>Enter a minimum of one digit before pressing .</li> </ul>
	<ul style="list-style-type: none"> <li>This message appears if the required number of digits are not entered in the bar code data.</li> </ul>	<ul style="list-style-type: none"> <li>Input the correct number of digits or change the bar code protocol.</li> </ul>
<b>CHECK BATTERIES!</b>	<ul style="list-style-type: none"> <li>This message appears if a combination of new and used batteries, a combination of batteries of different types (alkaline and Ni-MH), manufacturers or models, or a combination of recharged and uncharged batteries have been installed.</li> </ul>	<ul style="list-style-type: none"> <li>Replace the batteries with six new AA batteries of the same type.</li> <li>If rechargeable batteries are installed, recharge all batteries.</li> </ul>
<b>CHECK SETTING IN LABEL TYPE MODE!</b>	<ul style="list-style-type: none"> <li>This message appears if you try to change the settings for the Length function or Frame function after a Label Type mode with a preset label length or frame has already been selected.</li> </ul>	<ul style="list-style-type: none"> <li>Select a different Label Type mode.</li> </ul>



Error Message	Cause	Solution
<p>On 3/4" (18 mm) tape: <b>CHECK THE NUMBER OF LINES! 5 MAX</b></p> <p>On 1/2" (12 mm) tape: <b>CHECK THE NUMBER OF LINES! 3 MAX</b></p> <p>On 3/8" (9 mm) and 1/4" (6 mm) tape: <b>CHECK THE NUMBER OF LINES! 2 MAX</b></p>	<ul style="list-style-type: none"> <li>This message appears if you try to print or use the Preview function when the number of lines in the text is greater than the maximum possible for the installed tape.</li> </ul>	<ul style="list-style-type: none"> <li>Reduce the number of lines or install a wider tape.</li> </ul>
<p><b>CHOOSE COPIES LESS THAN 1000!</b></p>	<ul style="list-style-type: none"> <li>This message appears if more than 1000 copies were selected with the Print Option functions.</li> <li>Note the number of copies plus the number of sequential labels cannot exceed 1000.</li> </ul>	<ul style="list-style-type: none"> <li>Select less than 1000 copies.</li> </ul>
<p><b>CUTTER ERROR!</b></p>	<ul style="list-style-type: none"> <li>This message appears if the tape cutter button was pressed when  was pressed or the tape was being fed.</li> </ul>	<ul style="list-style-type: none"> <li>Release the tape cutter button. If  was pressed, press  to feed out any printed tape.</li> <li>If the problem cannot be corrected, contact your service representative.</li> </ul>
<p><b>IMAGE CHARACTER SIZE ERROR!</b></p>	<ul style="list-style-type: none"> <li>This message appears if a wide user-defined character image is entered when the <b>Vertical</b> Label Type mode is selected.</li> </ul>	<ul style="list-style-type: none"> <li>Change the Label Type mode or use a tall user-defined character image.</li> </ul>
<p><b>INPUT ABCD AT BEGIN &amp; END!</b></p>	<ul style="list-style-type: none"> <li>This message appears if a letter between A and D has not been entered at the beginning and end of the bar code data when the <b>CODABAR</b> protocol is selected.</li> </ul>	<ul style="list-style-type: none"> <li>Enter a letter between A and D at the beginning and end of the bar code data.</li> </ul>
<p><b>INSERT 1" TAPE</b></p>	<ul style="list-style-type: none"> <li>This message appears if a 1" (24-mm)-wide tape cassette is not installed when printing an Auto Format template created for 1" (24-mm)-wide tape.</li> </ul>	<ul style="list-style-type: none"> <li>Install a 1" (24-mm)-wide tape cassette.</li> </ul>
<p><b>INSERT 24mm TAPE</b></p>		

Error Message	Cause	Solution
<b>INSERT 3/4" TAPE</b>	<ul style="list-style-type: none"> <li>This message appears if a 3/4" (18-mm)-wide tape cassette is not installed when printing an Auto Format template created for 3/4" (18-mm)-wide tape.</li> </ul>	<ul style="list-style-type: none"> <li>Install a 3/4" (18-mm)-wide tape cassette.</li> </ul>
<b>INSERT 18mm TAPE</b>		
<b>INSERT 1/2" TAPE</b>	<ul style="list-style-type: none"> <li>This message appears if a 1/2" (12-mm)-wide tape cassette is not installed when printing an Auto Format template created for 1/2" (12-mm)-wide tape.</li> </ul>	<ul style="list-style-type: none"> <li>Install a 1/2" (12-mm)-wide tape cassette.</li> </ul>
<b>INSERT 12mm TAPE</b>		
<b>INSERT 3/8" TAPE</b>	<ul style="list-style-type: none"> <li>This message appears if a 3/8" (9-mm)-wide tape cassette is not installed when printing an Auto Format template created for 3/8" (9-mm)-wide tape.</li> </ul>	<ul style="list-style-type: none"> <li>Install a 3/8" (9-mm)-wide tape cassette.</li> </ul>
<b>INSERT 9mm TAPE</b>		
<b>INSERT 1/4" TAPE</b>	<ul style="list-style-type: none"> <li>This message appears if a 1/4" (6-mm)-wide tape cassette is not installed when printing an Auto Format template created for 1/4" (6-mm)-wide tape.</li> </ul>	<ul style="list-style-type: none"> <li>Install a 1/4" (6-mm)-wide tape cassette.</li> </ul>
<b>INSERT 6mm TAPE</b>		
<b>INSERT TAPE CASSETTE!</b>	<ul style="list-style-type: none"> <li>This message appears if no tape cassette is installed when you try to feed the tape, print or use the Preview function.</li> </ul>	<ul style="list-style-type: none"> <li>Install a tape cassette and try again.</li> </ul>
<b>LENGTH LIMIT!</b>	<ul style="list-style-type: none"> <li>This message appears if you try to print or use the Preview function when the length of the text is greater than the 40" (1 m) limit.</li> </ul>	<ul style="list-style-type: none"> <li>Delete some of the text.</li> </ul>
<b>MEMORY FULL!</b>	<ul style="list-style-type: none"> <li>This message appears if you try to store a text file after approximately 2000 characters have already been stored in the memory.</li> </ul>	<ul style="list-style-type: none"> <li>Delete an unwanted file to make space for the new one.</li> </ul>
<b>NO DATABASE OR INCORRECT FORMAT</b>	<ul style="list-style-type: none"> <li>This message appears if no database has been downloaded to the P-touch labeller when you press  then .</li> </ul>	<ul style="list-style-type: none"> <li>Download a database.</li> </ul>

Error Message	Cause	Solution
<b>NO FILES!</b>	<ul style="list-style-type: none"> <li>This message appears if no files are stored in the memory when you try to recall or delete one.</li> </ul>	<ul style="list-style-type: none"> <li>Store a text file before trying to recall or delete one.</li> </ul>
<b>OK TO REDUCE THE BLOCK NO.?</b>	<ul style="list-style-type: none"> <li>The message appears if you select the PANEL2 Label Type mode, and when the number of the desired blocks is less than that of the text mode, the number is reduced.</li> </ul>	<ul style="list-style-type: none"> <li>Press  to reduce.</li> <li>Press  to set the same or the more numbers of the blocks.</li> </ul>
<b>RECORD NOT FOUND!</b>	<ul style="list-style-type: none"> <li>This message appears when the specified text or record number cannot be found in the database.</li> </ul>	<ul style="list-style-type: none"> <li>Try searching for different text or a different record number.</li> </ul>
<b>TAPE CASSETTE CHANGED!</b>	<ul style="list-style-type: none"> <li>This message appears if the tape cassette was changed while the P-touch labeller paused for the tape to be cut.</li> </ul>	<ul style="list-style-type: none"> <li>Change the tape cassette back again.</li> </ul>
<b>TEXT TOO HIGH! XX BLOCK</b>	<ul style="list-style-type: none"> <li>This message appears if the size of the text is larger than the width of the installed tape.</li> </ul>	<ul style="list-style-type: none"> <li>Reduce the size of the characters, install a tape with a greater width, or select the <b>AUTO</b> text size setting.</li> </ul>
<b>TEXT TOO LONG!</b>	<ul style="list-style-type: none"> <li>This message appears if the length of the text is longer than the label length that has been set with the <b>Length</b> function.</li> </ul>	<ul style="list-style-type: none"> <li>Press , and then select a longer label length.</li> </ul>
<b>TEXT TOO LONG! XX BLOCK</b>	<ul style="list-style-type: none"> <li>This message appears if you try to print a label that is longer than the specified block length.</li> </ul>	<ul style="list-style-type: none"> <li>Select a longer block length.</li> </ul>
<b>VALUE OUT OF RANGE!</b>	<ul style="list-style-type: none"> <li>This message appears if the value entered while setting the <b>Margin</b>, <b>Length</b>, and <b>Block Length</b> function is not within the allowable range.</li> <li>This message appears if the specified characters cannot be found in the database.</li> <li>This message appears if the values for the blocks, records or fields to be printed is not within the allowable range.</li> </ul>	<ul style="list-style-type: none"> <li>Type in a value that is within the allowable range.</li> </ul>

# Machine Specifications

## Main Unit

Item	Specification
Input Device	Keyboard (56 key)

### Display

LCD	16 characters x 2 lines (132 dot x 48 dot) * Line indicator and 15 characters = 16 characters
LCD Contrast	5 levels (+2, +1, 0, -1, -2)
Back light	Yes

### Printing

Print method	Thermal printer
Print head	128 dot / 180 dpi
Print height	0.71" (18.1 mm) max. (when using 1" (24 mm) tape)
Print speed	0.39" (10 mm) / sec.
Tape cassette	Standard TZ tape cassette (1/4", 3/8", 1/2", 3/4", 1" [6, 9, 12, 18, 24 mm] widths)
Tape cutter	Manual
No. of lines	1" (24 mm) tape: 1 - 7 lines; 3/4" (18 mm) tape: 1 - 5 lines; 1/2" (12 mm) tape: 1 - 3 lines; 3/8" (9 mm) tape: 1 - 2 lines; 1/4" (6 mm) tape: 1 - 2 lines
Print direction	Horizontal, Vertical
Continuous printing	1 ~ 99 labels
Numbering printing	1 ~ 99 labels
Print preview	Yes

Item	Specification
<b>Characters</b>	
Internal character set	Total of 373 characters (62 alphanumeric, 164 symbols, 147 accented characters.)
Text buffer	Maximum 512 characters.
Fonts	Helsinki
Character size	Auto, 48 pt, 36 pt, 24 pt, 18 pt, 12 pt, 9 pt, 6 pt
Character style	Normal, Bold, Outline, Italic, Italic Bold, Italic Outline
Character width	Normal, Narrow, Minimum, Wide
Text alignment	Left, Center, Right, Justify
<b>Memory</b>	
Memory size	Maximum 2000 characters
<b>Other Features</b>	
Frame	15 frame patterns
Auto-Format	Templates: 10
PC Interface	Yes (Transfer Only)
Transfer Function	Download Templates and Image Characters (Max.10) Download Database x1
Label Type	Normal, Vertical, Rotate, Rotate & Repeat, Port, Panel1, Panel2, Flag
<b>Power Supply</b>	
Power supply	AC adapter (AD-18) Six AA-size alkaline batteries (LR6) Six AA-size rechargeable battery Ni-MH rechargeable battery pack (BA-7000)
Auto Power-off	5 minutes
<b>Size</b>	
Dimensions	5.28" (W) x 9.25" (D) x 3.07" (H) [134 mm (W) x 235 mm (D) x 78 mm (H)]
Weight	1.40 lb. (635 g) (without tape cassette and battery)
<b>Other</b>	
Operating temperature / humidity	10 ~ 35°C / 20 ~ 80% humidity (without condensation)

## Operating Environment: Windows®

Item	Specification
OS	Microsoft® Windows® XP/Windows Vista®/Windows® 7
Memory	Windows® XP: More than 128 MB Windows Vista®: More than 512 MB Windows® 7: More than 1 GB (32-bit) or 2 GB (64-bit)
Hard disk	70MB or more required
Monitor	SVGA High color graphics support or higher
Interface	USB Port (USB specification 1.1 or 2.0 protocol)
Other	CD-ROM drive for installation

## Accessories

Obtain tape cassettes from your nearest authorized dealer.

Use only Brother TZ tapes with this machine. **Brother cannot be held responsible for trouble caused by the use of unauthorized supplies.** Do not use tapes that do not have the  mark.

## Laminated Tapes

Stock No.	Description	Price
1" (24mm)-wide laminated tapes		
TZ-151	Black on Clear	\$25.99
TZ-155	White on Clear	\$32.95
TZ-251	Black on White	\$28.99
TZ-252	Red on White	\$28.99
TZ-253	Blue on White	\$28.99
TZ-354	Gold on Black	\$31.99
TZ-355	White on Black	\$31.99
TZ-451	Black on Red	\$28.99
TZ-651	Black on Yellow	\$28.99
TZ-B51	Black on Fluorescent Orange - 16.4 ft. (5 m) tape length	\$35.99
TZ-D51	Black on Fluorescent Green - 16.4 ft. (5 m) tape length	\$35.99
3/4" (18mm)-wide laminated tapes		
TZ-141	Black on Clear	\$22.99
TZ-241	Black on White	\$24.99
TZ-242	Red on White	\$24.99
TZ-243	Blue on White	\$24.99

Stock No.	Description	Price
TZ-344	Gold on Black	\$28.99
TZ-345	White on Black	\$28.99
TZ-545	White on Blue	\$28.99
TZ-641	Black on Yellow	\$24.99
TZ-B41	Black on Fluorescent Orange - 16.4 ft. (5 m) tape length	\$29.99
TZ-M41	Black on Matt Clear	\$24.99
1/2" (12mm)-wide laminated tapes		
TZ-131	Black on Clear	\$19.99
TZ-132	Red on Clear	\$19.99
TZ-133	Blue on Clear	\$19.99
TZ-135	White on Clear	\$23.95
TZ-231	Black on White	\$20.99
TZ-232	Red on White	\$20.99
TZ-233	Blue on White	\$20.99
TZ-334	Gold on Black	\$24.99
TZ-335	White on Black	\$24.99
TZ-431	Black on Red	\$20.99
TZ-435	White on Red	\$24.99
TZ-531	Black on Blue	\$20.99
TZ-631	Black on Yellow	\$20.99
TZ-731	Black on Green	\$20.99
TZ-M31	Black on Matt Clear	\$20.99
3/8" (9mm)-wide laminated tapes		
TZ-121	Black on Clear	\$16.99
TZ-221	Black on White	\$19.99
TZ-222	Red on White	\$19.99
TZ-223	Blue on White	\$19.99
TZ-325	White on Black	\$22.99
1/4" (6mm)-wide laminated tapes		
TZ-111	Black on Clear	\$14.99
TZ-211	Black on White	\$16.99
TZ-315	White on Black	\$20.99

## Non-laminated Tapes

Stock No.	Description	Price
3/4" (18mm)-wide non-laminated tapes		
TZ-N641	Black on Yellow	\$21.99
TZ-N541	Black on Blue	\$21.99
TZ-NF41	Black on Purple	\$21.99
1/2" (12mm)-wide non-laminated tapes		
TZ-N631	Black on Yellow	\$17.99
TZ-N531	Black on Blue	\$17.99

Stock No.	Description	Price
TZ-NF31	Black on Purple	\$17.99
9/64" (3.5 mm)-wide non-laminated tapes		
TZ-N201	Black on White	\$16.99

## Strong Adhesive Tapes:

Super Adhesive Strength: laminated tapes with twice the adhesive strength ideal for textured surfaces and harsh environments

Stock No.	Description	Price
1" (24 mm) wide laminated tapes		
TZ-S151	Black on Clear	\$31.99
TZ-S251	Black on White	\$31.99
TZ-S651	Black on Yellow	\$31.99
TZ-SM951	Black on Matt Silver	\$34.95
3/4" (18 mm)-wide laminated tapes		
TZ-S141	Black on Clear	\$27.99
TZ-S241	Black on White	\$27.99
TZ-S641	Black on Yellow	\$27.99
TZ-SM941	Black on Matt Silver	\$31.99
1/2" (12 mm)-wide laminated tapes		
TZ-S131	Black on Clear	\$23.99
TZ-S231	Black on White	\$23.99
TZ-S631	Black on Yellow	\$23.99
3/8" (9mm)-wide laminated tapes		
TZ-S221	Black on White	\$21.99
1/4" (6 mm)-wide laminated tapes		
TZ-S211	Black on White	\$19.99

## Flexible ID Tapes:

Special Adhesive for Bending, Wrapping & Flagging

Stock No.	Description	Price
TZ-FX251	Black on White 1" (24mm)	\$31.99
TZ-FX241	Black on White 3/4" (18mm)	\$27.99
TZ-FX231	Black on White 1/2" (12mm)	\$23.99

## Security Tape:

Security Pattern Appears If Removed

Stock No.	Description	Price
TZ-SE4	3/4" (18 mm) Black on White Security (tamper-evident) Tape - leaves a checkerboard pattern when removed	\$49.95



**Fabric Tape:**

Stock No.	Description	Price
TZ-FA3	1/2" (12 mm) Navy Blue on White Fabric Iron-on Tape -9.8ft. (3 m) tape length	\$34.95

**Head Cleaning Cassette:**

Stock No.	Description	Price
TZ-CL4	3/4" (18 mm) Print head cassette - approx. 100 uses	\$20.99

**Rechargeable battery pack**

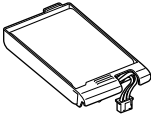
Stock No.	Description	Price
BA-7000		\$20.48

# Index

- A**
- AC adapter ..... 4
  - Accent function ..... 21
  - alignment ..... 32
  - arrow keys ..... 3, 18, 19
  - Auto Format function ..... 32
  - Auto Reduction function ..... 42
- B**
- backspace key ..... 3, 18, 21
  - bar code
    - special characters ..... 23
  - Bar Code function ..... 22
  - block number ..... 3
  - block range ..... 36
  - bold text style ..... 31
    - indicator ..... 3
- C**
- cancelling ..... 18
  - Caps indicator ..... 3
  - Caps mode ..... 19
  - center text alignment ..... 32
    - indicator ..... 3
  - chain printing ..... 41
  - character
    - size ..... 29
    - style ..... 31
    - width ..... 30
  - choosing ..... 18
    - default setting ..... 18
  - cleaning
    - print head ..... 44
    - rollers ..... 44
    - tape cutter ..... 44
  - Clear function ..... 21
  - Code indicator ..... 3
  - confirming ..... 18
  - Contrast function ..... 42
  - copies ..... 34
  - cursor ..... 19
  - Cut function ..... 41
  - cut-pause ..... 41
- D**
- database record range ..... 66
  - databases ..... 66, 67
    - Label Type mode ..... 68
    - searching ..... 69
  - default setting ..... 18
  - deleting
    - memory files ..... 39
    - text ..... 21
  - display ..... 3
    - contrast ..... 42
- E**
- error messages ..... 75
  - Extra Strength Adhesive Tape ..... 9
- F**
- Feed key ..... 3, 34
  - Flag mode ..... 14
  - flexible ID tape ..... 10
  - Format key ..... 29, 30, 31
  - formatting ..... 29, 30, 31
  - Frame function ..... 28
  - frame indicator ..... 3
- G**
- global format key ..... 3
  - global formatting
    - character size ..... 29
    - character style ..... 31
    - character width ..... 30

<b>I</b>	
indicators .....	3
block number .....	3
bold text style .....	3
Caps .....	3
center text alignment .....	3
Code .....	3
frame .....	3
Insert .....	3
italic text style .....	3
justified text alignment .....	3
Label Type setting .....	3
left text alignment .....	3
length .....	3
low battery .....	3
outline text style .....	3
right text alignment .....	3
Shift .....	3
size .....	3
width .....	3
Insert indicator .....	3
Insert key .....	20
italic text style .....	31
indicator .....	3
<b>J</b>	
justified text alignment .....	32
indicator .....	3
<b>K</b>	
keyboard .....	3
<b>L</b>	
label margins .....	27
Label Type key .....	3
Label Type mode .....	12
databases .....	68
Label Type setting indicator .....	3
LCD screen .....	3
left text alignment .....	32
indicator .....	3
length adjustment .....	42
Length function .....	27
length indicator .....	3
local formatting	
character size .....	29
character style .....	31
character width .....	30
low battery indicator .....	3
lowercase letters .....	19
<b>M</b>	
Margin function .....	27
Memory key .....	38
mirror printing .....	37
<b>N</b>	
New Block function .....	20
Normal mode .....	12
Numbering function .....	35
numbers .....	19
<b>O</b>	
outline text style .....	31
indicator .....	3
<b>P</b>	
Panel1 mode .....	15
Panel2 mode .....	16
PERSONAL symbol category .....	27
setup .....	43
PF keys .....	3
Port Block mode .....	15
Port mode .....	15
power key .....	3, 11
preview .....	33
print head .....	44
Print key .....	3, 34
printing	
database record range .....	66
text block range .....	36
problems .....	73

P-touch Editor	
starting .....	53
template .....	65

## **R**

recalling .....	39
Repeat Printing function .....	34
return key .....	3, 18, 20
right text alignment .....	32
indicator .....	3
rollers .....	44
Rotate & Repeat mode .....	13
Rotate mode .....	13

## **S**

searching .....	69
selecting .....	18, 19
default setting .....	18
Setup key .....	41
Shift indicator .....	3
Shift mode .....	19
size .....	29
indicator .....	3
Space key .....	18, 19
storing .....	38
style .....	31
Symbol key .....	24

## **T**

tape	
cutter .....	44
templates	
Auto Format .....	32
P-touch Editor .....	65
text	
alignment .....	32
size .....	29
size adjustment .....	42
style .....	31
width .....	30
width adjustment .....	42
Transfer mode .....	60

troubleshooting .....	73
-----------------------	----

## **U**

uppercase letters .....	19
user-defined character image .....	65

## **V**

version .....	43
Vertical mode .....	12

## **W**

width .....	30
indicator .....	3

**brother**®

Printed in China  
Imprimé en Chine  
LW5483001Ⓐ

